



ESTEHYNE S.L.

ESPECIALISTAS EN HIDRAULICA Y NEUMATICA

MANOMETROS

TARIFA 2022 Junio



WWW.hidraulicaneumatica.es





Ø 40	1/8" BSPP RADIAL		1/8" BSPP POST.	
	CLASE 1,6 SIN GLICERINA RELI		CLASE 1,6 SIN GLICERINA RELI	
ESCALA BAR	CODIGO	TARIFA	CODIGO	TARIFA
0/1,6	6081181100	15,70	6081281100	16,25
0/2,5	6081181200	15,70	6081281200	16,25
0/4	6081181300	15,70	6081281300	16,25
0/6	6081181400	15,70	6081281400	16,25
0/10	6081181500	15,70	6081281500	16,25
0/16	6081181600	15,70	6081281600	16,25
0/25	6081181700	15,70	6081281700	16,25
0/40	6081181800	15,70	6081281800	16,25
0/315			6081282300	21,87



Ø 50	1/4" BSPP RADIAL		1/4" BSPP POST.	
	CLASE 1,6 SIN GLICERINA RELI		CLASE 1,6 SIN GLICERINA RELI	
ESCALA BAR	CODIGO	TARIFA	CODIGO	TARIFA
-1/0	6082140800	16,53	6082240800	16,03
0/1	6082141000	16,53	6082241000	16,03
0/1,6	6082141100	16,53	6082241100	16,03
0/2,5	6082141200	16,53	6082241200	16,03
0/4	6082141300	16,53	6082241300	16,03
0/6	6082141400	16,53	6082241400	16,03
0/10	6082141500	13,18	6082241500	16,03
0/16	6082141600	13,18	6082241600	16,03
0/25	6082141700	13,18	6082241700	16,03
0/40	6082141800	16,53	6082241800	16,03
0/60	6082141900	16,53	6082241900	16,03
0/100	6082142000	16,53	6082242000	16,03
0/160	6082142100	16,53	6082242100	16,03
0/250	6082142200	16,53	6082242200	16,03
0/315	6082142300	16,53	6082242300	16,03
0/400	6082142400	16,53	6082242400	16,03

Ø 63	1/4" BSPP RADIAL		1/4" BSPP POST.	
	CLASE 1,6 CON GLICERINA		CLASE 1,6 CON GLICERINA	
ESCALA BAR	CODIGO	TARIFA	CODIGO	TARIFA
-1/+0,6	6053140100	14,67	6063240100	16,56
-1/+1,5	6053140200	14,67	6063240200	16,56
-1/+3	6053140300	14,67	6063240300	16,56
-1/+5	6053140400	14,67	6063240400	16,56
-1/+9	6053140500	14,67	6063240500	16,56
-1/+15	6053140600	14,67		
-1/+24	6053140700	14,67		
-1/0	6053140801	14,67	6063240801	16,56
0/0,6	6053140900	21,26	6063240900	23,54
0/1	6053141000	14,67	6063241000	16,56
0/1,6	6053141100	14,67	6063241100	16,56
0/2,5	6053141200	13,17	6063241200	15,13
0/4	6053141300	13,17	6063241300	15,13
0/6	6053141400	13,17	6063241400	15,13
0/10	6053141500	13,17	6063241500	15,13
0/16	6053141600	13,17	6063241600	15,13
0/25	6053141700	13,17	6063241700	15,13
0/40	6053141800	13,17	6063241800	15,13
0/60	6053141900	13,17	6063241900	15,13
0/100	6053142000	14,67	6063242000	16,56
0/160	6053142100	14,67	6063242100	16,56
0/250	6053142200	14,67	6063242200	16,56
0/315	6053142300	14,67	6063242300	16,56
0/400	6053142400	19,98	6063242400	20,02
0/600	6053142500	19,98	6063242500	20,02
0/1000	6053142600	24,29	6063242600	24,29

Ø 63	1/4" BSPP RADIAL		1/4" BSPP POST.	
	CLASE 1,6 SIN GLICERINA RELI		CLASE 1,6 SIN GLICERINA RELI	
ESCALA BAR	CODIGO	TARIFA	CODIGO	TARIFA
-1/+0,6	6083140100	14,67	6083240100	16,56
-1/+1,5	6083140200	14,67	6083240200	16,56
-1/+3	6083140300	14,67	6083240300	16,56
-1/+5	6083140400	14,67	6083240400	16,56
-1/+9	6083140500	14,67	6083240500	16,56
-1/+15	6083140600	14,67	6083240600	16,56
-1/+24	6083140700	14,67	6083240700	16,56
-1/0	6083140800	14,67	6083240800	16,56
0/0,6	6083140900	21,26	6083240900	23,54
0/1	6083141000	14,67	6083241000	16,56
0/1,6	6083141100	14,67	6083241100	16,56
0/2,5	6083141200	13,17	6083241200	15,13
0/4	6083141300	13,17	6083241300	15,13
0/6	6083141400	13,17	6083241400	15,13
0/10	6083141500	13,17	6083241500	15,13
0/16	6083141600	13,17	6083241600	15,13
0/25	6083141700	13,17	6083241700	15,13
0/40	6083141800	13,17	6083241800	15,13
0/60	6083141900	13,17	6083241900	15,13
0/100	6083142000	14,67	6083242000	16,56
0/160	6083142100	14,67	6083242100	16,56
0/250	6083142200	14,67	6083242200	16,56
0/315	6083142300	14,67	6083242300	16,56
0/400	6083142400	19,98	6083242400	20,02
0/600	6083142500	19,98	6083242500	20,02
0/1000	6083142600	24,29	6083242600	24,29



Ø 100	1/2" BSPP RADIAL		1/2" BSPP POST.	
	CLASE 1,6 CON GLICERINA		CLASE 1,6 CON GLICERINA	
				
ESCALA BAR	CODIGO	TARIFA	CODIGO	TARIFA
-1/+0,6	6055120100	43,39		
-1/+1,5	6055120200	43,39		
-1/+3	6055120300	43,39	6065220300	48,77
-1/+5	6055120400	43,39		
-1/+9	6055120500	43,39		
-1/+15	6055120600	43,39		
-1/+24	6055120700	43,39		
-1/0	6055120801	43,39	6065220800	48,77
0/0,6	6055120900	43,39		
0/1	6055121000	43,39	6065221000	48,77
0/1,6	6055121100	43,39		
0/2,5	6055121200	36,17	6065221200	48,77
0/4	6055121300	36,17	6065221300	42,50
0/6	6055121400	36,17	6065221400	42,50
0/10	6055121500	36,17	6065221500	42,50
0/16	6055121600	36,17	6065221600	42,50
0/25	6055121700	36,17	6065221700	42,50
0/40	6055121800	36,17	6065221800	42,50
0/60	6055121900	36,17	6065221900	42,50
0/100	6055122000	36,17	6065222000	42,50
0/160	6055122100	36,17	6065222100	42,50
0/250	6055122200	36,17	6065222200	42,50
0/315	6055122300	36,17	6065222300	42,50
0/400	6055122400	43,39	6065222400	48,77
0/600	6055122500	43,39	6065222500	48,77
0/1000	6055122600	58,34	6065222600	62,60

Ø 100	1/2" BSPP RADIAL		1/2" BSPP POST.	
	CLASE 1 SIN GLICERINA RELL		CLASE 1 SIN GLICERINA RELL	
				
ESCALA BAR	CODIGO	TARIFA	CODIGO	TARIFA
-1/+0,6	6175120100	57,46	6175220100	57,46
-1/+1,5	6175120200	57,46	6175220200	57,46
-1/+3	6175120300	57,46	6175220300	57,46
-1/+5	6175120400	57,46	6175220400	57,46
-1/+9	6175120500	57,46	6175220500	57,46
-1/+15	6175120600	57,46	6175220600	57,46
-1/+24	6175120700	57,46	6175220700	57,46
-1/0	6175120800	57,46	6175220800	57,46
0/0,6	6175120900	57,46	6175220900	57,46
0/1	6175121000	53,82	6175221000	53,82
0/1,6	6175121100	53,82	6175221100	53,82
0/2,5	6175121200	53,82	6175221200	53,82
0/4	6175121300	53,82	6175221300	53,82
0/6	6175121400	53,82	6175221400	53,82
0/10	6175121500	53,82	6175221500	53,82
0/16	6175121600	53,82	6175221600	53,82
0/25	6175121700	53,82	6175221700	53,82
0/40	6175121800	53,82	6175221800	53,82
0/60	6175121900	57,46	6175221900	57,46
0/100	6175122000	57,46	6175222000	57,46
0/160	6175122100	57,46	6175222100	57,46
0/250	6175122200	57,46	6175222200	57,46
0/315	6175122300	57,46	6175222300	57,46
0/400	6175122400	57,46	6175222400	57,46
0/600	6175122500	57,46	6175222500	57,46
0/1000	6175122600	57,46	6175222600	75,52

Ø 150	1/2" BSPP RADIAL	
	CLASE 1 SIN GLICERINA RELL	
		
ESCALA BAR	CODIGO	TARIFA
-1/+0,6	6176120100	117,47
-1/+1,5	6176120200	117,47
-1/+3	6176120300	117,47
-1/+5	6176120400	117,47
-1/+9	6176120500	117,47
-1/+15	6176120600	117,47
-1/+24	6176120700	117,47
-1/0	6176120800	104,58
0/0,6	6176120900	117,47
0/1	6176121000	104,58
0/1,6	6176121100	104,58
0/2,5	6176121200	104,58
0/4	6176121300	104,58
0/6	6176121400	104,58
0/10	6176121500	104,58
0/16	6176121600	104,58
0/25	6176121700	104,58
0/40	6176121800	104,58
0/60	6176121900	117,47
0/100	6176122000	117,47
0/160	6176122100	117,47
0/250	6176122200	117,47
0/315	6176122300	117,47
0/400	6176122400	117,47
0/600	6176122500	117,47
0/1000	6176122600	117,47

CARGA DE GLICERINA	PRECIOS NETOS
Ø40 / Ø50 / Ø63	6319300000 2,77
Ø100	6319500000 5,13
Ø150	6319600000 10,46

BORDE FRONTAL	CODIGO	TARIFA
Ø40 608118	6071000001	4,30
Ø50 608214	6072000001	4,30
Ø63 606324 / 608314	6070000001	4,60
Ø63 INOX	6070100001	7,64
Ø100 60652	6075000001	18,01
Ø100 617512 / INOX	6075100001	19,61
Ø150 INOX	6076100001	34,41

BRIDA TRASERA	CODIGO	TARIFA
Ø40 608128	6071000002	5,00
Ø50 608224	6072000002	5,00
Ø63 PARA 606324 / 608314	6070000002	5,01
Ø100 PARA 60652	6075000002	20,27

	PRECIOS NETOS
CERTIFICADO DE CALIB.	6300100000 17,24
CERTIFICADO ENAC HASTA 600 BAR	6300200000 208,18
CERTIFICADO ENAC HASTA 1600 BAR	6300200100 254,64
DESENGRASADO PARA OXÍGENO	6310000001 18,80



	MANOMETRO TODO INOX SIN GLICERINA, RELLENABLE TOMA RADIAL BSPP						
	CLASE 1,6		CLASE 1		CLASE 1		
	Ø63	1/4"	Ø100	1/2"	Ø150	1/2"	
ESCALA BAR	CODIGO	TARIFA	CODIGO	TARIFA	CODIGO	TARIFA	ESCALA BAR
-1/+0,6	6163140100	34,58	6165120100	75,29	6166120100	130,97	-1/+0,6
-1/+1,5	6163140200	34,58	6165120200	75,29	6166120200	130,97	-1/+1,5
-1/+3	6163140300	34,58	6165120300	75,29	6166120300	130,97	-1/+3
-1/+5	6163140400	34,58	6165120400	75,29	6166120400	130,97	-1/+5
-1/+9	6163140500	34,58	6165120500	75,29	6166120500	130,97	-1/+9
-1/+15	6163140600	34,58	6165120600	75,29	6166120600	130,97	-1/+15
-1/+24	6163140700	34,58	6165120700	75,29	6166120700	130,97	-1/+24
-1/0	6163140800	29,50	6165120800	72,72	6166120800	130,97	-1/0
0/0,6			6165120900	75,29	6166120900	130,97	0/0,6
0/1	6163141000	29,50	6165121000	72,72	6166121000	130,97	0/1
0/1,6	6163141100	29,50	6165121100	72,72	6166121100	130,97	0/1,6
0/2,5	6163141200	29,50	6165121200	72,72	6166121200	107,66	0/2,5
0/4	6163141300	29,50	6165121300	72,72	6166121300	107,66	0/4
0/6	6163141400	29,50	6165121400	72,72	6166121400	107,66	0/6
0/10	6163141500	29,50	6165121500	72,72	6166121500	107,66	0/10
0/16	6163141600	29,50	6165121600	72,72	6166121600	107,66	0/16
0/25	6163141700	29,50	6165121700	72,72	6166121700	107,66	0/25
0/40	6163141800	29,50	6165121800	72,72	6166121800	107,66	0/40
0/60	6163141900	29,50	6165121900	72,72	6166121900	130,97	0/60
0/100	6163142000	29,50	6165122000	72,72	6166122000	130,97	0/100
0/160	6163142100	29,50	6165122100	72,72	6166122100	130,97	0/160
0/250	6163142200	29,50	6165122200	72,72	6166122200	130,97	0/250
0/315	6163142300	29,50	6165122300	72,72	6166122300	130,97	0/315
0/400	6163142400	34,58	6165122400	72,72	6166122400	130,97	0/400
0/600	6163142500	34,58	6165122500	72,72	6166122500	130,97	0/600
0/1000	6163142600	34,58	6165122600	75,29	6166122600	130,97	0/1000

DISPONIBLES TAMBIEN CON ROSCA NPT

	MANOMETRO TODO INOX SIN GLICERINA, RELLENABLE TOMA POSTERIOR BSPP						
	CLASE 1,6		CLASE 1		CLASE 1		
	Ø63	1/4"	Ø100	1/2"	Ø150	1/2"	
ESCALA BAR	CODIGO	TARIFA	CODIGO	TARIFA	CODIGO	TARIFA	ESCALA BAR
-1/+0,6	6163240100	35,57	6165220100	85,93	6166220100	130,97	-1/+0,6
-1/+1,5	6163240200	35,57	6165220200	85,93	6166220200	130,97	-1/+1,5
-1/+3	6163240300	35,57	6165220300	85,93	6166220300	130,97	-1/+3
-1/+5	6163240400	35,57	6165220400	85,93	6166220400	130,97	-1/+5
-1/+9	6163240500	35,57	6165220500	85,93	6166220500	130,97	-1/+9
-1/+15	6163240600	35,57	6165220600	85,93	6166220600	130,97	-1/+15
-1/+24	6163240700	35,57	6165220700	85,93	6166220700	130,97	-1/+24
-1/0	6163240800	35,57	6165220800	85,93	6166220800	130,97	-1/0
0/0,6			6165220900	85,93	6166220900	130,97	0/0,6
0/1	6163241000	35,57	6165221000	85,93	6166221000	130,97	0/1
0/1,6	6163241100	35,57	6165221100	85,93	6166221100	130,97	0/1,6
0/2,5	6163241200	35,57	6165221200	85,93	6166221200	107,66	0/2,5
0/4	6163241300	35,57	6165221300	85,93	6166221300	107,66	0/4
0/6	6163241400	35,57	6165221400	85,93	6166221400	107,66	0/6
0/10	6163241500	35,57	6165221500	85,93	6166221500	107,66	0/10
0/16	6163241600	35,57	6165221600	85,93	6166221600	107,66	0/16
0/25	6163241700	35,57	6165221700	85,93	6166221700	107,66	0/25
0/40	6163241800	35,57	6165221800	85,93	6166221800	107,66	0/40
0/60	6163241900	35,57	6165221900	85,93	6166221900	130,97	0/60
0/100	6163242000	35,57	6165222000	85,93	6166222000	130,97	0/100
0/160	6163242100	35,57	6165222100	85,93	6166222100	130,97	0/160
0/250	6163242200	35,57	6165222200	85,93	6166222200	130,97	0/250
0/315	6163242300	35,57	6165222300	85,93	6166222300	130,97	0/315
0/400	6163242400	35,57	6165222400	85,93	6166222400	130,97	0/400
0/600	6163242500	35,57	6165222500	85,93	6166222500	130,97	0/600
0/1000	6163242600	35,57	6165222600	85,93	6166222600	130,97	0/1000



Ø 63	1/4" BSPP RADIAL		1/4" BSPP POST.		Ø 100	1/2" BSPP RADIAL		1/2" BSPP POST.	
	CLASE 1,6 SECO CARCASA INOX MECANICA LATON		CLASE 1,6 SECO CARCASA INOX MECANICA LATON			CLASE 1,6 SECO CARCASA INOX MECANICA LATON		CLASE 1,6 SECO CARCASA INOX MECANICA LATON	
mBar	CODIGO	TARIFA	CODIGO	TARIFA	mBar	CODIGO	TARIFA	CODIGO	TARIFA
-200/400	6133142502	44,24			-200/400				
-600/0	6133142501	44,24	6133242501	47,29	-600/0	6105122501	86,84	6105222501	102,08
-400/0	6133142401	44,24	6133242401	47,29	-400/0	6105122401	86,84	6105222401	102,08
-250/0	6133142201	44,24	6133242201	47,29	-250/0	6105122201	86,84	6105222201	102,08
-160/0	6133142101	44,24	6133242101	47,29	-160/0	6105122101	86,84	6105222101	102,08
-100/0	6133142001	44,24	6133242001	47,29	-100/0	6105122001	86,84	6105222001	102,08
-60/0	6133141901	44,24	6133241901	47,29	-60/0	6105121901	86,84	6105221901	102,08
-40/0	6133141801	44,24	6133241801	47,29	-40/0	6105121801	86,84	6105221801	102,08
-25/0	6133141701	44,24	6133241701	47,29	-25/0	6105121701	86,84	6105221701	102,08
0/25	6133141700	44,24	6133241700	47,29	0/25	6105121700	86,84	6105221700	102,08
0/40	6133141800	44,24	6133241800	47,29	0/40	6105121800	86,84	6105221800	102,08
0/60	6133141900	35,05	6133241900	47,29	0/60	6105121900	65,75	6105221900	102,08
0/100	6133142000	35,05	6133242000	47,29	0/100	6105122000	65,75	6105222000	94,03
0/160	6133142100	35,05	6133242100	47,29	0/160	6105122100	65,75	6105222100	94,03
0/250	6133142200	35,05	6133242200	47,29	0/250	6105122200	65,75	6105222200	94,03
0/400	6133142400	35,05	6133242400	47,29	0/400	6105122400	65,75	6105222400	94,03
0/600	6133142500	35,05	6133242500	47,29	0/600	6105122500	65,75	6105222500	94,03







Ø 63	1/4" BSPP RADIAL	
	CLASE 1,6 SECO TODO INOX	
mBar	CODIGO	TARIFA
0/100	6123142000	68,54
0/160	6123142100	68,54
0/250	6123142200	68,54

Ø 100	1/2" BSPP RADIAL		Ø 150	1/2" BSPP RADIAL	
	CLASE 1,6 SECO TODO INOX			CLASE 1,6 SECO TODO INOX	
mBar	CODIGO	TARIFA	mBar	CODIGO	TARIFA
-20/+20	6125121802	105,24			
-15/+25	6125121803	105,24			
-100/0	6125122001	105,24			
			0/10	6126121500	159,24
0/16	6125121600	71,57	0/16	6126121600	159,24
0/25	6125121700	71,57	0/25	6126121700	159,24
0/40	6125121800	71,57	0/40	6126121800	159,24
0/60	6125121900	71,57	0/60	6126121900	159,24
0/100	6125122000	71,57	0/100	6126122000	159,24
0/160	6125122100	71,57	0/160	6126122100	159,24
0/250	6125122200	71,57	0/250	6126122200	159,24
0/400	6125122400	71,57	0/400	6126122400	159,24
0/600	6125122500	71,57	0/600	6126122500	159,24

Ø	1/2" BSPP RADIAL	
	CLASE 1 SECO CARCASA INOX MECANICA LATON	
mBar	CODIGO	TARIFA
0/40	6115121800	95,39
0/60	6115121900	95,39
0/100	6115122000	95,39
0/160	6115122100	95,39
0/250	6115122200	95,39
0/400	6115122400	95,39
0/600	6115122500	95,39

Ø 63	1/2" BSPP RADIAL	
	CLASE 1,6 SECO DESENGRASADO EN-562 REGULADORES	
Bar	CODIGO	TARIFA
0/2,5	6093141200	11,57
0/10	6093141500	11,57
0/16	6093141600	11,57
0/25	6093141700	11,57
0/40	6093141800	11,57
0/60	6093141900	11,57
0/100	6093142000	11,57
0/315	6093142300	11,57
0/400	6093142400	11,57



<p>MANOMETROS PATRON CLASE 0,5 Y 0,25 Ø100 / Ø150</p> 	<p>MAN. DIGITALES CLASE 0,5 / 0,2 / 0,05</p> 	<p>MANOMETROS CON CONTACTOS</p> 	<p>SEPARADORES ALIMENTARIO INOX</p> 
<p>SEPARADORES</p> 	<p>TRANSMISORES DE PRESION</p> 	<p>TERMOMETROS CALEF / REFRIGERACION</p> 	
<p>TERMOMETROS CAPILLA</p> 	<p>PT100 KN / DIN B / ATEX</p> 	<p>TERMOMETRO INDUSTRIAL</p> 	<p>TERMOMETRO DIGITAL</p> 
<p>BOMBAS CALIBRACION</p> 	<p>BOMBAS COMPROBACION</p> 	<p>BALANZA PESOS MUERTOS</p> 	<p>CALIBRADOR TEMPERATURA</p> 
<p>PRESOSTATOS</p> 	<p>PRESOSTATOS NAUTILUS</p> 	<p>PRESOSTATO COMPRESOR</p> 	<p>GRIFOS Y ADAPTADORES</p> 

NO DUDE EN CONSULTANOS

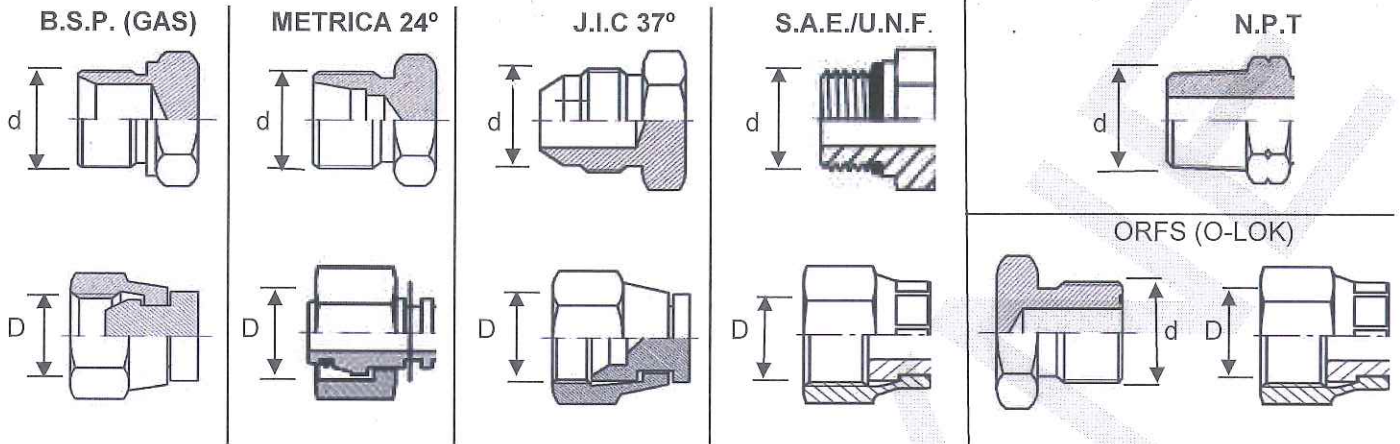

mm.	MACHO d	HEMBRA D
6,9		METRICA 8x1
8	METRICA 8x1	
8,4		JIC/SAE 3/8"-24
8,5		BSP 1/8"
8,9		METRICA 10x1
9,4	JIC/SAE 3/8"-24	
9,7	BSP 1/8"	
9,8		JIC/SAE 7/16"-20
10	METRICA 10x1	
10,2	NPT 1/8" -27	
10,3		METRICA 12x1,5
11	JIC/SAE 7/16-20	
11,4		BSP 1/4"
11,4		JIC/SAE 1/2"-20
12	METRICA 12x1,5	
12,3		METRICA 14x1,5
12,6	JIC/SAE 1/2"-20	
12,8		JIC/SAE 9/16"-18
13,1	BSP 1/4"	
13,7	NPT 1/4"-18	
14	METRICA 14x1,5	
14,2	JIC/SAE 9/16"-18	
14,3		METRICA 16X1,5
14,9		BSP 3/8"
15,8		JIC/SAE 11/16"-16
16	METRICA 16x1,5	
16,3		METRICA 18x1,5
16,6	BSP 3/8"	
17,2	NPT 3/8"-18	
17,4	JIC/SAE 11/16"-16	JIC/SAE 3/4"-16
18	METRICA 18x1,5	
18,3		METRICA 20x1,5
18,6		BSP 1/2"
19	JIC/SAE 3/4"16	JIC/SAE 13/16"-16
20	METRICA 20x1,5	
20,3		METRICA 22x1,5

mm.	MACHO d	HEMBRA D
20,4		JIC/SAE 7/8-16
20,5	JIC/SAE 13/16"-16	BSP 5/8"
20,9	BSP 1/2"	
21,3	NPT 1/2"-14	
22	METRICA 22x1,5	
22,1	JIC/SAE 7/8"-14	
22,3		METRICA 24x1,5
22,9	BSP 5/8"	
23,5		JIC/SAE 1"-14
24	METRICA 24x1,5	
24,1		BSP 3/4"
24,3		METRICA 26x1,5
24,8		JIC/SAE 1"1/16-12
25,3	JIC/SAE 1"-14	METRICA 27x1,5
26	METRICA 26x1,5	
26,4	BSP 3/4"	
26,6	NPT 3/4"-14	
26,9	JIC/SAE 1"1/16-12	
27	METRICA 27x1,5	
27,8		METRICA 30x2
28,1		JIC/SAE 1"3/16-12
28,3		METRICA 30x1,5
30	METRICA 30x1,5	
30	METRICA 30x2	
30,1	JIC/SAE 1"3/16-12	
30,2		BSP 1"
30,3		METRICA 32x1,5
31,2		JIC/SAE 1"5/16-12
31,3		METRICA 33x1,5
32	METRICA 32x1,5	
33	METRICA 33x1,5	
33,2	JIC/SAE 1"5/16-12	
33,2	BSP 1"	
33,4	NPT 1"-11,5	
33,8		METRICA 36s2
34,3		METRICA 36x1,5

mm.	MACHO d	HEMBRA D
34,4		JIC/SAE 1"7/16-12
36	METRICA 36x1,5	
36	METRICA 36x2	
36,3	JIC/SAE 1"7/16-12	METRICA 38x1,5
38	METRICA 38x1,5	
38,9		BSP 1"1/4
39,2		JIC/SAE 1"5/8-12
39,8		METRICA 42x2
40,7		JIC/SAE 1"11/16-12
41,2	JIC/SAE 1"5/8-12	
41,9	BSP 1"1/4	
42	METRICA 42x2	
42,1	NPT 1"1/4-11.5	
42,8	JIC/SAE 1"11/16-12	METRICA 45x2
43,3		METRICA 45x1,5
44,8		BSP 1"1/2
45	METRICA 45x1,5	
45	METRICA 45x2	
45,5		JIC/SAE 1"7/8-12
47,5	JIC/SAE 1"7/8-12	
47,8	BSP 1"1/2	
48,2	NPT 1"1/2-11.5	
48,7		JIC/SAE 2"-12
49,8		METRICA 52x2
50,3		METRICA 52x1,5
50,7	JIC/SAE 2"-12	
52	METRICA 52x1,5	
52	METRICA 52x2	
56,6		BSP 2"
59,6	BSP 2"	
60,3	NPT 2"-11.5	
61,4		JIC/SAE 2"1/2-12
62,8		METRICA 65x2
63,4	JIC/SAE 2"1/2-12	
65	METRICA 65x2	