



**ESTEHYNE S.L.**

*ESPECIALISTAS EN HIDRAULICA Y NEUMATICA*

**RACORES**  
**ACERO AL CARBONO**  
**DIN 2353**  
**TARIFA-2022**









[WWW.hidraulicaneumatica.es](http://WWW.hidraulicaneumatica.es)









## PAGINA 2

|   |   |   |   |   |   |   |
|---|---|---|---|---|---|---|
| TUERCA  | BICONO  | TAPON   | UNION IGUAL   | CODO IGUAL  | TE IGUAL  | CRUZ IGUAL  |
| DINATU  | DINABI  | DINAOB  | DINI  | DINI90  | DINITE  | DINICR  |
|  |  |  |  |  |  |  |



## PAGINA 3

|   |   |   |   |
|---|---|---|---|
| UNION DESIGUAL  | PASATAB.  | PASATAB. 90°  | TUERCA PASATAB.   |
| DINI  | DINIW   | DINIW90   | DINATM  |
|  |  |  |  |





## PAGINA 4

|   |
|---|
| REDUCCION T.LOCA  |
| DINRTT  |
|  |

## PAGINA 5

|   |   |
|---|---|
| UNION MACHO BSPP  | UNION MACHO BSPP C/J  |
| DINP  | DINP__J   |
|  |  |

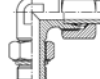

## PAGINA 6

|   |   |   |   |   |
|---|---|---|---|---|
| HEMBRA BSPP   | CODO BANJO BSPP   | CODO OR. BSPP   | UNION MANOMETRO   | ARANDELA MANOMETRO  |
| DINPH   | DINPBAE   | DINP90O   | DINPMA  | DINAARM   |
|  |  |  |  |  |

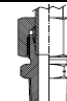
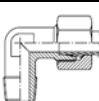

## PAGINA 7

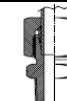
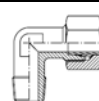
|   |   |
|---|---|
| MACHO BSPT  | CODO BSPT   |
| DINT  | DINT90  |
|  |  |

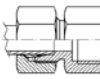
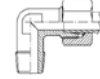

## PAGINA 8

|   |   |   |
|---|---|---|
| MACHO NPT   | CODO NPT  | MACHO UNF   |
| DINN  | DINN90  | DINU  |
|  |  |  |



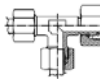
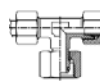

## PAGINA 9

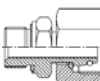
|   |   |   |   |
|---|---|---|---|
| MACHO METRICA   | HEMBRA METRICA  | CODO METRICA CONICA   | CODO BANJO METRICA  |
| DINM  | DINMH   | DINM90  | DINMBAE   |
|  |  |  |  |

## PAGINA 10

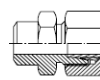
|   |   |   |   |   |   |
|---|---|---|---|---|---|
| CODO ORIENTABLE   | TE LATERAL ORIENTABLE   | TE CENTRAL ORIENTABLE   | UNION IGUAL ORIENTABLE  | ORIENTABLE METRICA  | ORIENTABLE BSPP   |
| DINTB   | DINITL  | DINITC  | DINGG   | DINMG   | DINPG   |
|  |  |  |  |  |  |

## PAGINA 11

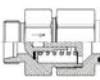
|   |   |   |   |   |   |
|---|---|---|---|---|---|
| PASATAB. SOLDAR   | UNION SOLDAR  | PUNTA SOLDAR  | ANTIRRET. TUBO->TUBO  | ANTIRRET. BSPP->TUBO  | ANTIRRET. TUBO->BSPP  |
| DINIWS  | DINAS   | DINASP  | DINIVA  | DINPVART  | DINPVATR  |
|  |  |  |  |  |  |



**TUERCAS - BICONOS - TAPONES - UNIONES TUBO-TUBO**

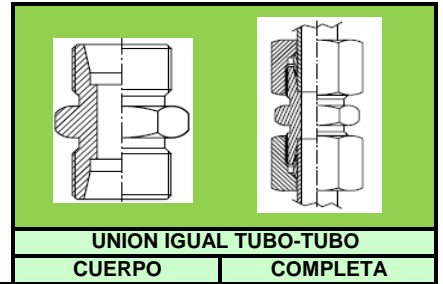
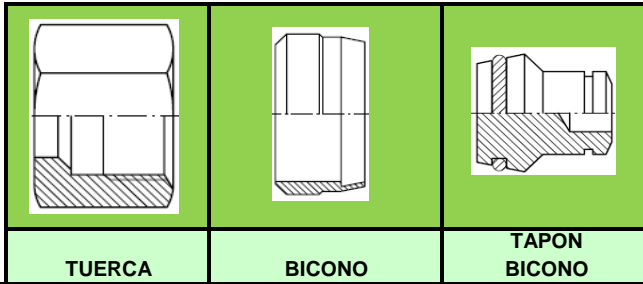

| TUBO  | CODIGO     | TARIFA | CODIGO     | TARIFA | CODIGO     | TARIFA |
|-------|------------|--------|------------|--------|------------|--------|
| 4-LL  | DINATU04LL | 0,45   | DINABI04LL | 0,29   |            |        |
| 6-LL  | DINATU06LL | 0,46   | DINABI06LL | 0,31   |            |        |
| 8-LL  | DINATU08LL | 0,52   | DINABI08LL | 0,37   |            |        |
| 10-LL | DINATU10LL | 0,58   | DINABI10LL | 0,40   |            |        |
| 12-LL | DINATU12LL | 0,61   | DINABI12LL | 1,32   |            |        |
| 6-L   | DINATU06L  | 0,34   | DINABI06LS | 0,32   | DINAOB06LS | 0,64   |
| 8-L   | DINATU08L  | 0,30   | DINABI08LS | 0,31   | DINAOB08LS | 0,62   |
| 10-L  | DINATU10L  | 0,38   | DINABI10LS | 0,41   | DINAOB10LS | 0,71   |
| 12-L  | DINATU12L  | 0,46   | DINABI12LS | 0,42   | DINAOB12LS | 0,79   |
| 15-L  | DINATU15L  | 0,70   | DINABI15L  | 0,45   | DINAOB15L  | 1,62   |
| 18-L  | DINATU18L  | 1,14   | DINABI18L  | 0,65   | DINAOB18L  | 1,18   |
| 22-L  | DINATU22L  | 1,60   | DINABI22L  | 0,79   | DINAOB22L  | 1,57   |
| 28-L  | DINATU28L  | 2,66   | DINABI28L  | 1,01   | DINAOB28L  | 2,06   |
| 35-L  | DINATU35L  | 5,96   | DINABI35L  | 1,38   | DINAOB35L  | 5,96   |
| 42-L  | DINATU42L  | 8,17   | DINABI42L  | 2,60   | DINAOB42L  | 8,81   |
| 6-S   | DINATU06S  | 0,50   | DINABI06LS | 0,32   | DINAOB06LS | 0,64   |
| 8-S   | DINATU08S  | 0,55   | DINABI08LS | 0,31   | DINAOB08LS | 0,62   |
| 10-S  | DINATU10S  | 0,55   | DINABI10LS | 0,41   | DINAOB10LS | 0,71   |
| 12-S  | DINATU12S  | 0,56   | DINABI12LS | 0,42   | DINAOB12LS | 0,79   |
| 14-S  | DINATU14S  | 1,13   | DINABI14S  | 0,56   | DINAOB14S  | 1,07   |
| 16-S  | DINATU16S  | 1,16   | DINABI16S  | 0,65   | DINAOB16S  | 1,09   |
| 20-S  | DINATU20S  | 1,81   | DINABI20S  | 0,79   | DINAOB20S  | 1,46   |
| 25-S  | DINATU25S  | 3,74   | DINABI25S  | 1,01   | DINAOB25S  | 2,04   |
| 30-S  | DINATU30S  | 5,79   | DINABI30S  | 1,23   | DINAOB30S  | 3,06   |
| 38-S  | DINATU38S  | 9,79   | DINABI38S  | 2,04   | DINAOB38S  | 8,34   |

| TUBO  | CODIGO   | TARIFA | CODIGO     | TARIFA |
|-------|----------|--------|------------|--------|
| 4-LL  | DINI04LL | 1,39   | DINI04LLTB | 3,55   |
| 6-LL  | DINI06LL | 1,34   | DINI06LLTB | 3,53   |
| 8-LL  | DINI08LL | 1,35   | DINI08LLTB | 3,82   |
| 10-LL | DINI10LL | 1,92   | DINI10LLTB | 4,14   |
| 10-LL | DINI12LL | 4,08   | DINI12LLTB | 4,08   |
| 6-L   | DINI06L  | 0,77   | DINI06LTB  | 2,37   |
| 8-L   | DINI08L  | 0,82   | DINI08LTB  | 2,77   |
| 10-L  | DINI10L  | 0,90   | DINI10LTB  | 2,82   |
| 12-L  | DINI12L  | 0,91   | DINI12LTB  | 3,07   |
| 15-L  | DINI15L  | 1,47   | DINI15LTB  | 4,42   |
| 18-L  | DINI18L  | 1,76   | DINI18LTB  | 5,84   |
| 22-L  | DINI22L  | 2,75   | DINI22LTB  | 8,35   |
| 28-L  | DINI28L  | 3,98   | DINI28LTB  | 12,46  |
| 35-L  | DINI35L  | 10,03  | DINI35LTB  | 23,38  |
| 42-L  | DINI42L  | 14,60  | DINI42LTB  | 31,32  |
| 6-S   | DINI06S  | 1,30   | DINI06STB  | 3,77   |
| 8-S   | DINI08S  | 1,73   | DINI08STB  | 4,32   |
| 10-S  | DINI10S  | 1,46   | DINI10STB  | 3,79   |
| 12-S  | DINI12S  | 1,50   | DINI12STB  | 4,13   |
| 14-S  | DINI14S  | 1,82   | DINI14STB  | 5,71   |
| 16-S  | DINI16S  | 1,98   | DINI16STB  | 6,46   |
| 20-S  | DINI20S  | 3,67   | DINI20STB  | 9,40   |
| 25-S  | DINI25S  | 5,75   | DINI25STB  | 14,50  |
| 30-S  | DINI30S  | 7,15   | DINI30STB  | 20,67  |
| 38-S  | DINI38S  | 17,14  | DINI38STB  | 35,20  |

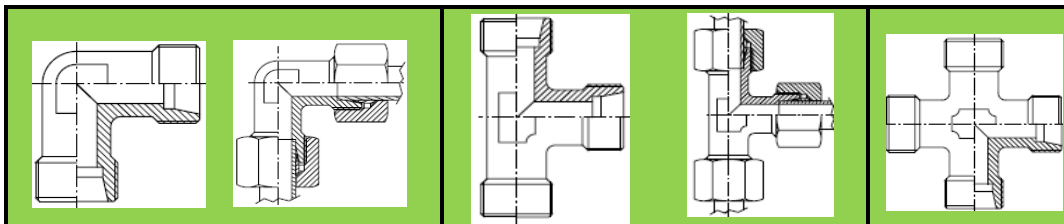

| TUBO | CODO IGUAL TUBO-TUBO |        |              |        | TE IGUAL   |        |              |        | CRUZ IGUAL |        |
|------|----------------------|--------|--------------|--------|------------|--------|--------------|--------|------------|--------|
|      | CODIGO               | TARIFA | CODIGO       | TARIFA | CODIGO     | TARIFA | CODIGO       | TARIFA | CODIGO     | TARIFA |
| 4-LL | DINI9004LL           | 2,85   | DINI9004LLTB | 5,01   | DINITE04LL | 4,31   | DINITE04LLTB | 7,55   |            |        |
| 6-LL | DINI9006LL           | 2,85   | DINI9006LLTB | 5,03   | DINITE06LL | 3,53   | DINITE06LLTB | 6,81   |            |        |
| 8-LL | DINI9008LL           | 3,30   | DINI9008LLTB | 5,76   | DINITE08LL | 4,26   | DINITE08LLTB | 7,97   |            |        |
| 6-L  | DINI9006L            | 2,26   | DINI9006LTB  | 4,11   | DINITE06L  | 2,96   | DINITE06LTB  | 5,49   | DINICR06L  | 10,82  |
| 8-L  | DINI9008L            | 2,39   | DINI9008LTB  | 4,41   | DINITE08L  | 2,96   | DINITE08LTB  | 5,55   | DINICR08L  | 13,43  |
| 10-L | DINI9010L            | 2,47   | DINI9010LTB  | 4,46   | DINITE10L  | 3,57   | DINITE10LTB  | 6,39   | DINICR10L  | 13,44  |
| 12-L | DINI9012L            | 2,79   | DINI9012LTB  | 4,76   | DINITE12L  | 4,13   | DINITE12LTB  | 7,35   | DINICR12L  | 13,65  |
| 15-L | DINI9015L            | 4,32   | DINI9015LTB  | 7,31   | DINITE15L  | 4,76   | DINITE15LTB  | 9,48   | DINICR15L  | 16,88  |
| 18-L | DINI9018L            | 5,40   | DINI9018LTB  | 9,12   | DINITE18L  | 7,69   | DINITE18LTB  | 13,73  | DINICR18L  | 24,01  |
| 22-L | DINI9022L            | 6,65   | DINI9022LTB  | 11,93  | DINITE22L  | 10,14  | DINITE22LTB  | 15,46  | DINICR22L  | 44,90  |
| 28-L | DINI9028L            | 11,79  | DINI9028LTB  | 17,24  | DINITE28L  | 16,32  | DINITE28LTB  | 23,69  | DINICR28L  | 47,26  |
| 35-L | DINI9035L            | 24,99  | DINI9035LTB  | 37,97  | DINITE35L  | 44,32  | DINITE35LTB  | 57,41  | DINICR35L  | 79,70  |
| 42-L | DINI9042L            | 30,47  | DINI9042LTB  | 43,93  | DINITE42L  | 57,77  | DINITE42LTB  | 82,53  | DINICR42L  | 127,43 |
| 6-S  | DINI9006S            | 4,44   | DINI9006STB  | 6,91   | DINITE06S  | 4,63   | DINITE06STB  | 8,33   | DINICR06S  | 17,53  |
| 8-S  | DINI9008S            | 4,63   | DINI9008STB  | 7,23   | DINITE08S  | 7,35   | DINITE08STB  | 11,25  | DINICR08S  | 18,43  |
| 10-S | DINI9010S            | 3,49   | DINI9010STB  | 6,38   | DINITE10S  | 4,07   | DINITE10STB  | 8,63   | DINICR10S  | 18,83  |
| 12-S | DINI9012S            | 3,23   | DINI9012STB  | 5,78   | DINITE12S  | 4,54   | DINITE12STB  | 9,37   | DINICR12S  | 20,05  |
| 14-S | DINI9014S            | 4,76   | DINI9014STB  | 8,86   | DINITE14S  | 5,06   | DINITE14STB  | 12,21  | DINICR14S  | 27,27  |
| 16-S | DINI9016S            | 5,21   | DINI9016STB  | 9,38   | DINITE16S  | 7,69   | DINITE16STB  | 13,36  | DINICR16S  | 27,37  |
| 20-S | DINI9020S            | 7,13   | DINI9020STB  | 13,30  | DINITE20S  | 10,31  | DINITE20STB  | 17,83  | DINICR20S  | 41,92  |
| 25-S | DINI9025S            | 11,10  | DINI9025STB  | 18,95  | DINITE25S  | 13,46  | DINITE25STB  | 28,06  | DINICR25S  | 47,66  |
| 30-S | DINI9030S            | 19,26  | DINI9030STB  | 30,42  | DINITE30S  | 22,65  | DINITE30STB  | 35,60  | DINICR30S  | 92,92  |
| 38-S | DINI9038S            | 28,45  | DINI9038STB  | 43,57  | DINITE38S  | 43,02  | DINITE38STB  | 65,66  | DINICR38S  | 127,43 |



## UNION / PASATABIQUES TUBO-TUBO

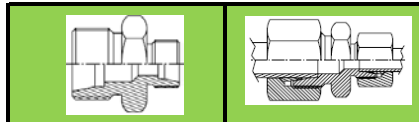

UNION DESIGUAL

CUERPO

COMPLETA

| TUBO   | CODIGO    | TARIFA | CODIGO      | TARIFA |
|--------|-----------|--------|-------------|--------|
| 8-6L   | DINI0806L | 1,52   | DINI0806LTB | 3,86   |
| 10-6L  | DINI1006L | 1,60   | DINI1006LTB | 4,17   |
| 10-8L  | DINI1008L | 1,73   | DINI1008LTB | 4,27   |
| 12-6L  | DINI1206L | 4,85   |             |        |
| 12-8L  | DINI1208L | 1,72   | DINI1208LTB | 4,41   |
| 12-10L | DINI1210L | 1,76   | DINI1210LTB | 4,68   |
| 15-10L | DINI1510L | 2,67   | DINI1510LTB | 6,07   |
| 15-12L | DINI1512L | 2,63   | DINI1512LTB | 6,18   |
| 18-10L | DINI1810L | 8,79   |             |        |
| 18-12L | DINI1812L | 3,10   | DINI1812LTB | 7,45   |
| 18-15L | DINI1815L | 2,94   | DINI1815LTB | 7,77   |
| 22-12L | DINI2212L | 15,34  |             |        |
| 22-15L | DINI2215L | 5,16   | DINI2215LTB | 10,95  |
| 22-18L | DINI2218L | 4,57   | DINI2218LTB | 11,15  |
| 28-18L | DINI2818L | 24,64  |             |        |
| 28-22L | DINI2822L | 7,37   | DINI2822LTB | 14,47  |
| 35-22L | DINI3522L | 24,76  | DINI3522LTB | 31,43  |
| 35-28L | DINI3528L | 24,76  | DINI3528LTB | 32,70  |
| 8-6S   | DINI0806S | 1,96   | DINI0806STB | 1,96   |
| 10-6S  | DINI1006S | 1,90   | DINI1006STB | 4,74   |
| 10-8S  | DINI1008S | 2,05   | DINI1008STB | 4,96   |
| 12-6S  | DINI1206S | 2,79   | DINI1206STB | 5,71   |
| 12-8S  | DINI1208S | 3,33   | DINI1208STB | 6,32   |
| 12-10S | DINI1210S | 3,33   | DINI1210STB | 6,62   |
| 14-10S | DINI1410S | 3,07   | DINI1410STB | 7,32   |
| 14-12S | DINI1412S | 2,98   | DINI1412STB | 7,31   |
| 16-12S | DINI1612S | 3,41   | DINI1612STB | 7,92   |
| 16-14S | DINI1614S | 3,54   | DINI1614STB | 9,02   |
| 20-10S | DINI2010S | 13,34  |             |        |
| 20-12S | DINI2012S | 5,92   | DINI2012STB | 11,63  |
| 20-14S | DINI2014S | 15,68  |             |        |
| 20-16S | DINI2016S | 5,60   | DINI2016STB | 12,46  |
| 25-16S | DINI2516S | 8,76   | DINI2516STB | 16,12  |
| 25-20S | DINI2520S | 10,32  | DINI2520STB | 18,52  |
| 30-20S | DINI3020S | 24,04  | DINI3020STB | 34,96  |
| 30-25S | DINI3025S | 24,43  | DINI3025STB | 37,53  |
| 38-30S | DINI3830S | 34,45  | DINI3830STB | 47,00  |

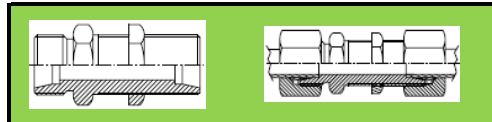

PASATABIQUES RECTO

CUERPO

COMPLETA

| TUBO | CODIGO   | TARIFA | CODIGO     | TARIFA |
|------|----------|--------|------------|--------|
| 6-L  | DINIW06L | 2,72   | DINIW06LTB | 5,08   |
| 8-L  | DINIW08L | 3,34   | DINIW08LTB | 5,66   |
| 10-L | DINIW10L | 4,03   | DINIW10LTB | 6,81   |
| 12-L | DINIW12L | 4,96   | DINIW12LTB | 8,02   |
| 15-L | DINIW15L | 6,19   | DINIW15LTB | 10,23  |
| 18-L | DINIW18L | 8,89   | DINIW18LTB | 14,52  |
| 22-L | DINIW22L | 11,82  | DINIW22LTB | 16,94  |
| 28-L | DINIW28L | 13,99  | DINIW28LTB | 23,44  |
| 35-L | DINIW35L | 23,12  | DINIW35LTB | 33,53  |
| 42-L | DINIW42L | 31,03  | DINIW42LTB | 44,43  |
| 6-S  | DINIW06S | 3,87   | DINIW06STB | 6,34   |
| 8-S  | DINIW08S | 4,32   | DINIW08STB | 6,92   |
| 10-S | DINIW10S | 5,19   | DINIW10STB | 8,40   |
| 12-S | DINIW12S | 6,48   | DINIW12STB | 9,85   |
| 14-S | DINIW14S | 9,25   | DINIW14STB | 14,55  |
| 16-S | DINIW16S | 9,74   | DINIW16STB | 13,48  |
| 20-S | DINIW20S | 14,82  | DINIW20STB | 20,01  |
| 25-S | DINIW25S | 21,45  | DINIW25STB | 29,69  |
| 30-S | DINIW30S | 25,20  | DINIW30STB | 40,78  |
| 38-S | DINIW38S | 62,73  | DINIW38STB | 80,69  |

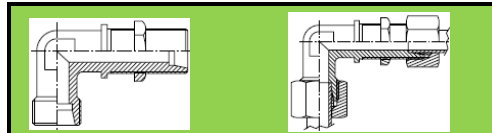

PASATABIQUES 90°

CUERPO

COMPLETA

| TUBO | CODIGO     | TARIFA | CODIGO       | TARIFA |
|------|------------|--------|--------------|--------|
| 6-L  | DINIW9006L | 7,45   | DINIW9006LTB | 9,82   |
| 8-L  | DINIW9008L | 7,65   | DINIW9008LTB | 9,97   |
| 10-L | DINIW9010L | 7,79   | DINIW9010LTB | 10,57  |
| 12-L | DINIW9012L | 10,29  | DINIW9012LTB | 13,35  |
| 15-L | DINIW9015L | 11,16  | DINIW9015LTB | 13,29  |
| 18-L | DINIW9018L | 14,30  | DINIW9018LTB | 17,44  |
| 22-L | DINIW9022L | 15,43  | DINIW9022LTB | 22,03  |
| 28-L | DINIW9028L | 25,85  | DINIW9028LTB | 34,25  |
| 35-L | DINIW9035L | 32,99  | DINIW9035LTB | 45,97  |
| 42-L | DINIW9042L | 50,55  | DINIW9042LTB | 67,05  |
| 6-S  | DINIW9006S | 9,81   | DINIW9006STB | 11,54  |
| 8-S  | DINIW9008S | 9,80   | DINIW9008STB | 12,40  |
| 10-S | DINIW9010S | 9,40   | DINIW9010STB | 12,61  |
| 12-S | DINIW9012S | 11,05  | DINIW9012STB | 14,42  |
| 14-S | DINIW9014S | 10,80  | DINIW9014STB | 14,08  |
| 16-S | DINIW9016S | 13,31  | DINIW9016STB | 18,26  |
| 20-S | DINIW9020S | 18,81  | DINIW9020STB | 25,85  |
| 25-S | DINIW9025S | 28,53  | DINIW9025STB | 39,15  |
| 30-S | DINIW9030S | 35,66  | DINIW9030STB | 46,12  |
| 38-S | DINIW9038S | 60,18  | DINIW9038STB | 78,14  |

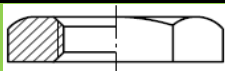

TUERCA PASATABIQUES

|      |      |         |             |      |
|------|------|---------|-------------|------|
| 6-L  |      | M12*150 | DINATM12150 | 0,63 |
| 8-L  | 6-S  | M14*150 | DINATM14150 | 0,80 |
| 10-L | 8-S  | M16*150 | DINATM16150 | 0,82 |
| 12-L | 10-S | M18*150 | DINATM18150 | 0,97 |
|      | 12-S | M20*150 | DINATM20150 | 1,15 |
| 15-L | 14-S | M22*150 | DINATM22150 | 1,56 |
|      | 16-S | M24*150 | DINATM24150 | 1,65 |
| 18-L |      | M26*150 | DINATM26150 | 2,34 |
| 22-L | 20-S | M30*200 | DINATM30200 | 2,40 |
| 28-L | 25-S | M36*200 | DINATM36200 | 2,94 |
|      | 30-S | M42*200 | DINATM42200 | 3,15 |
| 35-L |      | M45*200 | DINATM45200 | 3,15 |
| 42-L | 35-S | M52*200 | DINATM52200 | 6,09 |



## REDUCCIONES

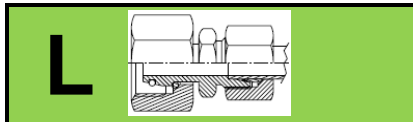

**REDUCCION TUBO TUBO**

**CUERPO                      COMPLETA**

| TUBO   | CODIGO      | TARIFA | CODIGO        | TARIFA |
|--------|-------------|--------|---------------|--------|
| 8-6L   | DINRTT0806L | 3,93   | DINRTT0806LTB | 6,27   |
| 10-6L  | DINRTT1006L | 4,54   | DINRTT1006LTB | 7,11   |
| 10-8L  | DINRTT1008L | 3,62   | DINRTT1008LTB | 6,16   |
| 12-6L  | DINRTT1206L | 4,2    | DINRTT1206LTB | 6,91   |
| 12-8L  | DINRTT1208L | 2,39   | DINRTT1208LTB | 5,07   |
| 12-10L | DINRTT1210L | 4,39   | DINRTT1210LTB | 7,31   |
| 15-06L |             |        | DINRTT1506LTB | 16,54  |
| 15-08L | DINRTT1508L | 6,82   | DINRTT1508LTB | 10,00  |
| 15-10L | DINRTT1510L | 5,25   | DINRTT1510LTB | 8,66   |
| 15-12L | DINRTT1512L | 4,87   | DINRTT1512LTB | 8,42   |
| 18-6L  | DINRTT1806L | 17,02  | DINRTT1806LTB | 20,52  |
| 18-8L  | DINRTT1808L | 17,04  | DINRTT1808LTB | 20,51  |
| 18-10L | DINRTT1810L | 6,68   | DINRTT1810LTB | 10,89  |
| 18-12L | DINRTT1812L | 8,34   | DINRTT1812LTB | 12,69  |
| 18-15L | DINRTT1815L | 9,4    | DINRTT1815LTB | 14,24  |
| 22-06L |             |        | DINRTT2206LTB | 22,08  |
| 22-08L |             |        | DINRTT2208LTB |        |
| 22-10L | DINRTT2210L | 18,98  | DINRTT2210LTB | 23,49  |
| 22-12L | DINRTT2212L | 11,74  | DINRTT2212LTB | 14,91  |
| 22-15L | DINRTT2215L | 11,74  | DINRTT2215LTB | 15,34  |
| 22-18L | DINRTT2218L | 9,97   | DINRTT2218LTB | 14,48  |
| 28-6L  |             |        | DINRTT2806LTB | 23,84  |
| 28-8L  |             |        | DINRTT2808LTB |        |
| 28-10L |             |        | DINRTT2810LTB | 24,40  |
| 28-12L | DINRTT2812L | 23,34  | DINRTT2812LTB | 26,13  |
| 28-15L | DINRTT2815L | 14,23  | DINRTT2815LTB | 20,72  |
| 28-18L | DINRTT2818L | 14,23  | DINRTT2818LTB | 21,42  |
| 28-22L | DINRTT2822L | 12,7   | DINRTT2822LTB | 19,13  |
| 35-15L | DINRTT3515L | 29,61  | DINRTT3515LTB | 37,67  |
| 35-18L | DINRTT3518L | 29,61  | DINRTT3518LTB | 38,29  |
| 35-22L | DINRTT3522L | 18,25  | DINRTT3522LTB | 25,64  |
| 35-28L | DINRTT3528L | 25,33  | DINRTT3528LTB | 33,21  |
| 42-18L | DINRTT4218L | 41,87  | DINRTT4218LTB | 52,09  |
| 42-22L | DINRTT4222L | 42,36  | DINRTT4222LTB | 53,25  |
| 42-28L | DINRTT4228L | 42,63  | DINRTT4228LTB | 54,66  |
| 42-35L | DINRTT4235L | 24     | DINRTT4235LTB | 39,66  |

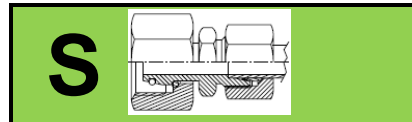

**REDUCCION TUBO TUBO**

**CUERPO                      COMPLETA**

| TUBO   | CODIGO      | TARIFA | CODIGO        | TARIFA |
|--------|-------------|--------|---------------|--------|
| 8-6S   | DINRTT0806S | 13,71  | DINRTT0806STB | 14,21  |
| 10-6S  | DINRTT1006S | 13,13  | DINRTT1006STB | 15,62  |
| 10-8S  | DINRTT1008S | 14,86  | DINRTT1008STB | 15,55  |
| 12-6S  | DINRTT1206S | 13,36  | DINRTT1206STB | 15,91  |
| 12-8S  | DINRTT1208S | 13,36  | DINRTT1208STB | 15,97  |
| 12-10S | DINRTT1210S | 6,5    | DINRTT1210STB | 9,79   |
| 14-06S | DINRTT1406S | 15,14  | DINRTT1406STB | 18,50  |
| 14-08S | DINRTT1408S | 15,16  | DINRTT1408STB | 18,62  |
| 14-10S | DINRTT1410S | 15,16  | DINRTT1410STB | 18,89  |
| 14-12S | DINRTT1412S | 6,23   | DINRTT1412STB | 10,57  |
| 16-08S | DINRTT1608S | 9,05   | DINRTT1608STB | 13,18  |
| 16-10S | DINRTT1610S | 17,5   | DINRTT1610STB | 21,38  |
| 16-12S | DINRTT1612S | 7,16   | DINRTT1612STB | 11,68  |
| 16-14S | DINRTT1614S | 18,33  | DINRTT1614STB | 23,13  |
| 20-6S  | DINRTT2006S | 20,97  | DINRTT2006STB | 25,37  |
| 20-8S  | DINRTT2008S | 20,97  | DINRTT2008STB | 25,63  |
| 20-10S | DINRTT2010S | 20,97  | DINRTT2010STB | 25,90  |
| 20-12S | DINRTT2012S | 13,44  | DINRTT2012STB | 16,75  |
| 20-14S | DINRTT2014S | 13,89  | DINRTT2014STB | 19,73  |
| 20-16S | DINRTT2016S | 11,36  | DINRTT2016STB | 15,94  |
| 25-12S | DINRTT2506S | 25,68  | DINRTT2506STB | 29,10  |
| 25-12S | DINRTT2508S | 25,68  | DINRTT2508STB | 29,15  |
| 25-12S | DINRTT2510S | 25,68  | DINRTT2510STB | 29,39  |
| 25-12S | DINRTT2512S | 15,23  | DINRTT2512STB | 22,68  |
| 25-14S | DINRTT2514S | 23,44  | DINRTT2514STB | 30,81  |
| 25-16S | DINRTT2516S | 12,47  | DINRTT2516STB | 19,36  |
| 25-20S | DINRTT2520S | 14,46  | DINRTT2520STB | 22,15  |
| 30-12S |             |        | DINRTT3012STB |        |
| 30-16S |             |        | DINRTT3016STB | 40,53  |
| 30-20S |             |        | DINRTT3020STB | 34,75  |
| 30-12S |             |        | DINRTT3012STB |        |
| 30-16S |             |        | DINRTT3016STB | 40,53  |
| 30-25S |             |        | DINRTT3025STB | 42,11  |
| 38-12S |             |        | DINRTT3812STB |        |
| 38-16S |             |        | DINRTT3816STB | 50,08  |
| 38-20S |             |        | DINRTT3820STB | 54,22  |
| 38-25S |             |        | DINRTT3825STB | 61,02  |
| 38-30S |             |        | DINRTT3830STB | 65,53  |



## UNIONES MACHO BSPP



UNION MACHO BSPP

CUERPO COMPLETA

| TUBO | BSPP   | CODIGO    | TARIFA | CODIGO      | TARIFA |
|------|--------|-----------|--------|-------------|--------|
| 6-L  | 1/8"   | DINP0610L | 0,82   | DINP0610LTB | 1,66   |
| 6-L  | 1/4"   | DINP0613L | 1,18   | DINP0613LTB | 1,84   |
| 6-L  | 3/8"   | DINP0617L | 2,10   | DINP0617LTB | 3,28   |
| 6-L  | 1/2"   | DINP0621L | 2,39   | DINP0621LTB | 3,57   |
| 8-L  | 1/8"   | DINP0810L | 1,00   | DINP0810LTB | 1,94   |
| 8-L  | 1/4"   | DINP0813L | 1,10   | DINP0813LTB | 1,96   |
| 8-L  | 3/8"   | DINP0817L | 1,53   | DINP0817LTB | 2,36   |
| 8-L  | 1/2"   | DINP0821L | 3,54   | DINP0821LTB | 4,70   |
| 10-L | 1/8"   | DINP1010L | 2,01   | DINP1010LTB | 3,40   |
| 10-L | 1/4"   | DINP1013L | 1,10   | DINP1013LTB | 2,08   |
| 10-L | 3/8"   | DINP1017L | 1,34   | DINP1017LTB | 2,52   |
| 10-L | 1/2"   | DINP1021L | 1,95   | DINP1021LTB | 2,92   |
| 12-L | 1/4"   | DINP1213L | 1,94   | DINP1213LTB | 3,47   |
| 12-L | 3/8"   | DINP1217L | 1,10   | DINP1217LTB | 2,36   |
| 12-L | 1/2"   | DINP1221L | 2,66   | DINP1221LTB | 4,19   |
| 12-L | 3/4"   | DINP1227L | 3,54   | DINP1227LTB | 5,07   |
| 15-L | 3/8"   | DINP1517L | 1,53   | DINP1517LTB | 3,07   |
| 15-L | 1/2"   | DINP1521L | 1,92   | DINP1521LTB | 3,34   |
| 15-L | 3/4"   | DINP1527L | 3,44   | DINP1527LTB | 5,46   |
| 18-L | 3/8"   | DINP1817L | 2,39   | DINP1817LTB | 5,21   |
| 18-L | 1/2"   | DINP1821L | 1,92   | DINP1821LTB | 4,00   |
| 18-L | 3/4"   | DINP1827L | 4,96   | DINP1827LTB | 7,77   |
| 22-L | 1/2"   | DINP2221L | 2,74   | DINP2221LTB | 5,78   |
| 22-L | 3/4"   | DINP2227L | 2,86   | DINP2227LTB | 5,78   |
| 22-L | 1"     | DINP2234L | 9,44   | DINP2234LTB | 13,20  |
| 28-L | 3/4"   | DINP2827L | 8,98   | DINP2827LTB | 14,38  |
| 28-L | 1"     | DINP2834L | 5,22   | DINP2834LTB | 9,79   |
| 28-L | 1.1/4" |           |        |             |        |
| 35-L | 1"     | DINP3534L | 13,80  | DINP3534LTB | 19,38  |
| 35-L | 1.1/4" | DINP3542L | 13,28  | DINP3542LTB | 18,92  |
| 35-L | 1.1/2" |           |        |             |        |
| 42-L | 1.1/2" | DINP4249L | 16,29  | DINP4249LTB | 23,65  |
| 6-S  | 1/4"   | DINP0613S | 1,95   | DINP0613STB | 3,18   |
| 8-S  | 1/4"   | DINP0813S | 1,85   | DINP0813STB | 3,15   |
| 8-S  | 3/8"   | DINP0817S | 2,48   | DINP0817STB | 3,78   |
| 10-S | 1/4"   | DINP1013S | 1,59   | DINP1013STB | 2,69   |
| 10-S | 3/8"   | DINP1017S | 1,70   | DINP1017STB | 3,03   |
| 10-S | 1/2"   | DINP1021S | 2,88   | DINP1021STB | 4,48   |
| 12-S | 1/4"   | DINP1213S | 2,37   | DINP1213STB | 4,06   |
| 12-S | 3/8"   | DINP1217S | 1,62   | DINP1217STB | 2,93   |
| 12-S | 1/2"   | DINP1221S | 3,22   | DINP1221STB | 4,90   |
| 14-S | 3/8"   | DINP1417S | 2,51   | DINP1417STB | 5,16   |
| 14-S | 1/2"   | DINP1421S | 3,45   | DINP1421STB | 6,10   |
| 16-S | 3/8"   | DINP1617S | 3,34   | DINP1617STB | 6,17   |
| 16-S | 1/2"   | DINP1621S | 2,29   | DINP1621STB | 4,62   |
| 16-S | 3/4"   | DINP1627S | 5,03   | DINP1627STB | 7,86   |
| 20-S | 1/2"   | DINP2021S | 5,73   | DINP2021STB | 9,75   |
| 20-S | 3/4"   | DINP2027S | 3,54   | DINP2027STB | 6,60   |
| 20-S | 1"     |           |        |             |        |
| 25-S | 3/4"   | DINP2527S | 8,41   | DINP2527STB | 13,33  |
| 25-S | 1"     | DINP2534S | 7,66   | DINP2534STB | 14,49  |
| 25-S | 1.1/4" |           |        |             |        |
| 30-S | 1"     | DINP3034S | 10,36  | DINP3034STB | 17,83  |
| 30-S | 1.1/4" | DINP3042S | 13,28  | DINP3042STB | 20,39  |
| 30-S | 1.1/2" |           |        |             |        |
| 38-S | 1.1/4" | DINP3842S | 9,74   | DINP3842STB | 19,75  |
| 38-S | 1.1/2" | DINP3849S | 15,11  | DINP3849STB | 23,41  |

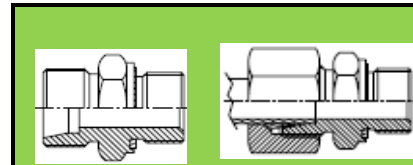

UNION MACHO BSPP C/JUNTA

CUERPO COMPLETA

| TUBO | BSPP   | CODIGO     | TARIFA | CODIGO       | TARIFA |
|------|--------|------------|--------|--------------|--------|
| 6-L  | 1/8"   | DINP0610LJ | 1,14   | DINP0610LJTB | 2,01   |
| 6-L  | 1/4"   | DINP0613LJ | 1,48   | DINP0613LJTB | 2,18   |
| 6-L  | 3/8"   |            |        |              |        |
| 6-L  | 1/2"   |            |        |              |        |
| 8-L  | 1/8"   | DINP0810LJ | 1,09   | DINP0810LJTB | 2,13   |
| 8-L  | 1/4"   | DINP0813LJ | 1,21   | DINP0813LJTB | 2,09   |
| 8-L  | 3/8"   | DINP0817LJ | 1,26   | DINP0817LJTB | 2,32   |
| 8-L  | 1/2"   |            |        |              |        |
| 10-L | 1/8"   |            |        |              |        |
| 10-L | 1/4"   | DINP1013LJ | 1,09   | DINP1013LJTB | 2,07   |
| 10-L | 3/8"   | DINP1017LJ | 1,48   | DINP1017LJTB | 2,47   |
| 10-L | 1/2"   | DINP1021LJ | 2,04   | DINP1021LJTB | 3,19   |
| 12-L | 1/4"   | DINP1213LJ | 1,74   | DINP1213LJTB | 3,27   |
| 12-L | 3/8"   | DINP1217LJ | 1,10   | DINP1217LJTB | 2,41   |
| 12-L | 1/2"   | DINP1221LJ | 3,02   | DINP1221LJTB | 4,55   |
| 12-L | 3/4"   |            |        |              |        |
| 15-L | 3/8"   | DINP1517LJ | 1,71   | DINP1517LJTB | 3,42   |
| 15-L | 1/2"   | DINP1521LJ | 2,04   | DINP1521LJTB | 3,73   |
| 15-L | 3/4"   | DINP1527LJ | 5,29   |              |        |
| 18-L | 3/8"   |            |        |              |        |
| 18-L | 1/2"   | DINP1821LJ | 2,08   | DINP1821LJTB | 4,41   |
| 18-L | 3/4"   | DINP1827LJ | 4,44   | DINP1827LJTB | 7,26   |
| 22-L | 1/2"   | DINP2221LJ | 2,85   |              |        |
| 22-L | 3/4"   | DINP2227LJ | 3,03   | DINP2227LJTB | 6,03   |
| 22-L | 1"     | DINP2234LJ | 8,33   |              |        |
| 28-L | 3/4"   | DINP2827LJ | 8,33   |              |        |
| 28-L | 1"     | DINP2834LJ | 5,37   | DINP2834LJTB | 9,98   |
| 28-L | 1.1/4" |            |        |              |        |
| 35-L | 1"     |            |        |              |        |
| 35-L | 1.1/4" | DINP3542LJ | 14,13  | DINP3542LJTB | 19,66  |
| 35-L | 1.1/2" |            |        |              |        |
| 42-L | 1.1/2" | DINP4249LJ | 18,26  | DINP4249LJTB | 25,40  |
| 6-S  | 1/4"   | DINP0613SJ | 2,22   | DINP0613SJTB | 3,45   |
| 8-S  | 1/4"   | DINP0813SJ | 2,06   | DINP0813SJTB | 3,36   |
| 8-S  | 3/8"   | DINP0817SJ | 2,80   | DINP0817SJTB | 4,10   |
| 10-S | 1/4"   | DINP1013SJ | 1,33   | DINP1013SJTB | 2,69   |
| 10-S | 3/8"   | DINP1017SJ | 1,77   | DINP1017SJTB | 3,17   |
| 10-S | 1/2"   | DINP1021SJ | 2,79   | DINP1021SJTB | 4,40   |
| 12-S | 1/4"   | DINP1213SJ | 2,53   | DINP1213SJTB | 4,21   |
| 12-S | 3/8"   | DINP1217SJ | 1,40   | DINP1217SJTB | 2,85   |
| 12-S | 1/2"   | DINP1221SJ | 3,45   | DINP1221SJTB | 5,14   |
| 14-S | 3/8"   |            |        |              |        |
| 14-S | 1/2"   | DINP1421SJ | 3,74   | DINP1421SJTB | 6,39   |
| 16-S | 3/8"   | DINP1617SJ | 3,31   | DINP1617SJTB | 6,14   |
| 16-S | 1/2"   | DINP1621SJ | 2,28   | DINP1621SJTB | 4,47   |
| 16-S | 3/4"   | DINP1627SJ | 3,54   | DINP1627SJTB | 6,37   |
| 20-S | 1/2"   |            |        |              |        |
| 20-S | 3/4"   | DINP2027SJ | 3,41   | DINP2027SJTB | 6,58   |
| 20-S | 1"     |            |        |              |        |
| 25-S | 3/4"   | DINP2527SJ | 9,26   | DINP2527SJTB | 14,08  |
| 25-S | 1"     | DINP2534SJ | 8,98   | DINP2534SJTB | 13,84  |
| 25-S | 1.1/4" |            |        |              |        |
| 30-S | 1"     |            |        |              |        |
| 30-S | 1.1/4" | DINP3042SJ | 13,97  | DINP3042SJTB | 22,74  |
| 30-S | 1.1/2" |            |        |              |        |
| 38-S | 1.1/4" |            |        |              |        |
| 38-S | 1.1/2" | DINP3849SJ | 21,14  | DINP3849SJTB | 28,77  |



## UNIONES BSPP - TOMAS MANOMETRO

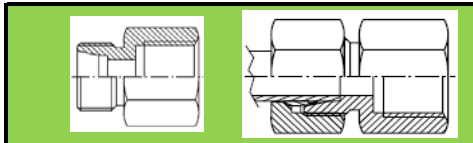

UNION HEMBRA BSPP

CUERPO

COMPLETA

| TUBO | BSPP   | CODIGO     | TARIFA | CODIGO       | TARIFA |
|------|--------|------------|--------|--------------|--------|
| 6-L  | 1/8"   | DINPH0610L | 2,15   | DINPH0610LTB | 3,34   |
| 6-L  | 1/4"   |            |        |              |        |
| 8-L  | 1/4"   | DINPH0813L | 2,23   | DINPH0813LTB | 3,39   |
| 10-L | 1/4"   | DINPH1013L | 2,28   | DINPH1013LTB | 3,67   |
| 10-L | 3/8"   | DINPH1017L | 2,74   | DINPH1017LTB | 4,13   |
| 10-L | 1/2"   | DINPH1021L | 5,01   | DINPH1021LTB | 6,40   |
| 12-L | 3/8"   | DINPH1217L | 2,72   | DINPH1217LTB | 4,25   |
| 12-L | 1/2"   | DINPH1221L | 3,61   | DINPH1221LTB | 5,14   |
| 15-L | 1/2"   | DINPH1521L | 3,39   | DINPH1521LTB | 5,41   |
| 18-L | 1/2"   | DINPH1821L | 3,58   | DINPH1821LTB | 6,40   |
| 22-L | 3/4"   | DINPH2227L | 5,68   | DINPH2227LTB | 9,45   |
| 28-L | 1"     | DINPH2834L | 9,30   | DINPH2834LTB | 14,70  |
| 35-L | 1.1/4" | DINPH3542L | 34,34  | DINPH3542LTB | 40,83  |
| 42-L | 1.1/2" | DINPH4249L | 41,04  | DINPH4249LTB | 45,19  |
| 6-S  | 1/4"   | DINPH0613S | 2,77   | DINPH0613STB | 4,01   |
| 8-S  | 1/4"   | DINPH0813S | 2,77   | DINPH0813STB | 4,07   |
| 10-S | 3/8"   | DINPH1017S | 4,13   | DINPH1017STB | 5,74   |
| 12-S | 3/8"   | DINPH1217S | 2,72   | DINPH1217STB |        |
| 14-S | 3/8"   |            |        | DINPH1417STB |        |
| 14-S | 1/2"   | DINPH1421S | 4,17   | DINPH1421STB | 6,82   |
| 16-S | 1/2"   | DINPH1621S | 4,44   | DINPH1621STB | 7,27   |
| 20-S | 3/4"   | DINPH2027S | 7,68   | DINPH2027STB | 11,70  |
| 25-S | 1"     | DINPH2534S | 10,33  | DINPH2534STB | 15,01  |
| 30-S | 1.1/4" | DINPH3042S | 35,46  | DINPH3042STB | 43,25  |
| 38-S | 1.1/2" | DINPH3849S | 42,93  | DINPH3849STB | 51,91  |

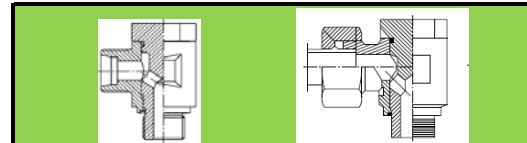

CODO BANJO BSPP

CUERPO

COMPLETA

| TUBO | BSPP   | CODIGO        | TARIFA | CODIGO          | TARIFA |
|------|--------|---------------|--------|-----------------|--------|
| 6-LL | 1/8"   | DINPBAE0610LL | 11,79  | DINPBAE0610LLTB | 12,89  |
| 8-LL | 1/8"   | DINPBAE0810LL | 11,79  | DINPBAE0810LLTB | 13,03  |
| 6-L  | 1/8"   | DINPBAE0610L  | 11,16  | DINPBAE0610LTB  | 12,34  |
| 6-L  | 1/4"   |               |        |                 |        |
| 8-L  | 1/4"   | DINPBAE0813L  | 9,43   | DINPBAE0813LTB  | 11,01  |
| 10-L | 1/4"   | DINPBAE1013L  | 7,34   | DINPBAE1013LTB  | 8,10   |
| 12-L | 3/8"   | DINPBAE1217L  | 8,32   | DINPBAE1217LTB  | 9,38   |
| 12-L | 1/2"   |               |        |                 |        |
| 15-L | 1/2"   | DINPBAE1521L  | 14,65  | DINPBAE1521LTB  | 17,19  |
| 18-L | 1/2"   | DINPBAE1821L  | 25,42  | DINPBAE1821LTB  | 24,79  |
| 22-L | 3/4"   | DINPBAE2227L  | 34,61  | DINPBAE2227LTB  | 37,54  |
| 28-L | 1"     | DINPBAE2834L  | 65,52  | DINPBAE2834LTB  | 69,30  |
| 35-L | 1.1/4" | DINPBAE3542L  | 108,74 | DINPBAE3542LTB  | 114,58 |
| 42-L | 1.1/2" | DINPBAE4249L  | 138,49 | DINPBAE4249LTB  | 146,74 |
| 6-S  | 1/4"   | DINPBAE0613S  | 13,76  | DINPBAE0613STB  | 14,84  |
| 8-S  | 1/4"   | DINPBAE0813S  | 13,77  | DINPBAE0813STB  | 14,91  |
| 10-S | 3/8"   | DINPBAE1017S  | 16,29  | DINPBAE1017STB  | 17,70  |
| 12-S | 3/8"   | DINPBAE1217S  | 17,63  | DINPBAE1217STB  | 19,10  |
| 14-S | 3/8"   |               |        |                 |        |
| 14-S | 1/2"   | DINPBAE1421S  | 24,39  | DINPBAE1421STB  | 23,74  |
| 16-S | 1/2"   | DINPBAE1621S  | 14,96  | DINPBAE1621STB  | 19,27  |
| 20-S | 3/4"   | DINPBAE2027S  | 31,17  | DINPBAE2027STB  | 34,30  |
| 25-S | 1"     | DINPBAE2534S  | 65,52  | DINPBAE2534STB  | 70,30  |
| 30-S | 1.1/4" | DINPBAE3042S  | 108,74 | DINPBAE3042STB  | 115,75 |
| 38-S | 1.1/2" | DINPBAE3849S  | 138,49 | DINPBAE3849STB  | 147,47 |

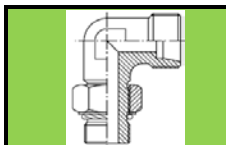

CODO ORIENT.BSPP

CUERPO

| TUBO | BSPP | CODIGO       | TARIFA |
|------|------|--------------|--------|
| 6-L  | 1/8" | DINP9000610L | 8,34   |
| 8-L  | 1/4" | DINP9000813L | 9,49   |
| 10-L | 1/4" | DINP9001013L | 9,49   |
| 12-L | 3/8" | DINP9001217L | 12,37  |
| 15-L | 1/2" | DINP9001521L | 14,28  |
| 18-L | 1/2" | DINP9001821L | 20,35  |
| 22-L | 3/4" | DINP9002227L | 22,21  |
| 16-S | 1/2" | DINP9001621S | 22,49  |
| 20-S | 3/4" | DINP9002027S | 22,21  |
| 25-S | 1"   | DINP9002534S | 39,66  |

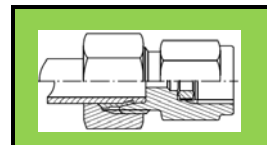

MANOMETRO

COMPLETA

| TUBO | ROSCA | CODIGO        | TARIFA |
|------|-------|---------------|--------|
| 6-L  | 1/4"  | DINPMA0613LTB | 3,47   |
| 8-L  | 1/4"  | DINPMA0813LTB | 3,44   |
| 10-L | 1/4"  | DINPMA1013LTB | 3,67   |
| 12-L | 1/4"  | DINPMA1213LTB | 3,76   |
| 6-S  | 1/2"  | DINPMA0621STB | 10,70  |
| 8-S  | 1/2"  | DINPMA0821STB | 10,90  |
| 10-S | 1/2"  | DINPMA1021STB | 11,30  |
| 12-S | 1/2"  | DINPMA1221STB | 11,84  |



ARANDELA MANOMETRO

| MANOMETRO | CODIGO    | TARIFA |
|-----------|-----------|--------|
| 1/4"      | DINAARM13 | 0,64   |
| 1/2"      | DINAARM21 | 1,02   |





## UNIONES BSPT

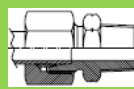
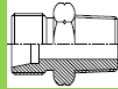

UNION MACHO BSPT

CUERPO

COMPLETA

| TUBO  | BSPT   | CODIGO     | TARIFA | CODIGO       | TARIFA |
|-------|--------|------------|--------|--------------|--------|
| 4-LL  | 1/8"   | DINT0410LL | 1,09   | DINT0410LLTB | 2,17   |
| 6-LL  | 1/8"   | DINT0610LL | 1,09   | DINT0610LLTB | 2,18   |
| 8-LL  | 1/8"   | DINT0810LL | 1,12   | DINT0810LLTB | 2,35   |
| 8-LL  | 1/4"   | DINT0813LL | 1,24   |              |        |
| 10-LL | 1/8"   | DINT0810LL | 1,12   |              |        |
| 6-L   | 1/8"   | DINT0610L  | 1,14   | DINT0610LTB  | 2,32   |
| 6-L   | 1/4"   | DINT0613L  | 1,61   | DINT0613LTB  | 2,79   |
| 8-L   | 1/8"   |            |        |              |        |
| 8-L   | 1/4"   | DINT0813L  | 1,56   | DINT0813LTB  | 2,72   |
| 8-L   | 3/8"   |            |        |              |        |
| 8-L   | 1/2"   |            |        |              |        |
| 10-L  | 1/8"   |            |        |              |        |
| 10-L  | 1/4"   | DINT1013L  | 1,56   | DINT1013LTB  | 2,95   |
| 10-L  | 3/8"   | DINT1017L  | 1,91   | DINT1017LTB  | 3,30   |
| 10-L  | 1/2"   |            |        |              |        |
| 12-L  | 1/4"   | DINT1213L  | 1,95   | DINT1213LTB  | 3,48   |
| 12-L  | 3/8"   | DINT1217L  | 1,92   | DINT1217LTB  | 3,45   |
| 12-L  | 1/2"   | DINT1221L  | 2,57   | DINT1221LTB  | 4,10   |
| 15-L  | 3/8"   | DINT1517L  | 2,04   | DINT1517LTB  | 4,06   |
| 15-L  | 1/2"   | DINT1521L  | 2,64   | DINT1521LTB  | 4,66   |
| 18-L  | 1/2"   | DINT1821L  | 3,39   | DINT1821LTB  | 6,21   |
| 22-L  | 3/4"   | DINT2227L  | 4,50   | DINT2227LTB  | 8,27   |
| 28-L  | 1"     |            |        |              |        |
| 35-L  | 1.1/4" |            |        |              |        |
| 42-L  | 1.1/2" |            |        |              |        |
| 6-S   | 1/4"   | DINT0613S  | 1,72   | DINT0613STB  | 2,95   |
| 8-S   | 1/4"   | DINT0813S  | 1,95   | DINT0813STB  | 3,25   |
| 8-S   | 3/8"   |            |        |              |        |
| 8-S   | 1/2"   |            |        |              |        |
| 10-S  | 1/4"   |            |        |              |        |
| 10-S  | 3/8"   | DINT1017S  | 1,97   | DINT1017STB  | 3,57   |
| 10-S  | 1/2"   |            |        |              |        |
| 12-S  | 3/8"   | DINT1217S  | 2,51   | DINT1217STB  | 4,19   |
| 12-S  | 1/2"   |            |        |              |        |
| 14-S  | 1/2"   | DINT1421S  | 10,61  |              |        |
| 16-S  | 1/2"   | DINT1621S  | 3,83   | DINT1621STB  | 6,66   |
| 20-S  | 3/4"   | DINT2027S  | 7,12   | DINT2027STB  | 11,14  |
| 25-S  | 1"     |            |        |              |        |
| 30-S  | 1.1/4" |            |        |              |        |
| 38-S  | 1.1/2" |            |        |              |        |

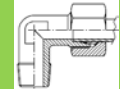

CODO MACHO BSPT

CUERPO

COMPLETA

| TUBO  | BSPT   | CODIGO       | TARIFA | CODIGO         | TARIFA |
|-------|--------|--------------|--------|----------------|--------|
| 4-LL  | 1/8"   | DINT900410LL | 3,45   | DINT900410LLTB | 4,53   |
| 6-LL  | 1/8"   | DINT900610LL | 3,45   | DINT900610LLTB | 4,54   |
| 8-LL  | 1/8"   | DINT900810LL | 4,00   | DINT900810LLTB | 5,23   |
| 10-LL | 1/8"   | DINT901013LL | 0,00   |                |        |
| 6-L   | 1/8"   | DINT900610L  | 2,46   | DINT900610LTB  | 3,16   |
| 6-L   | 1/4"   | DINT900613L  | 2,39   | DINT900613LTB  | 3,29   |
| 8-L   | 1/8"   | DINT900810L  | 2,77   | DINT900810LTB  | 3,68   |
| 8-L   | 1/4"   | DINT900813L  | 2,55   | DINT900813LTB  | 3,58   |
| 8-L   | 3/8"   | DINT900817L  | 6,22   | DINT900817LTB  | 7,37   |
| 8-L   | 1/2"   |              |        |                |        |
| 10-L  | 1/8"   |              |        |                |        |
| 10-L  | 1/4"   | DINT901013L  | 2,84   | DINT901013LTB  | 3,87   |
| 10-L  | 3/8"   | DINT901017L  | 4,34   | DINT901017LTB  | 5,73   |
| 10-L  | 1/2"   | DINT901021L  | 8,33   | DINT901021LTB  | 9,72   |
| 12-L  | 1/4"   | DINT901213L  | 4,42   | DINT901213LTB  | 5,95   |
| 12-L  | 3/8"   | DINT901217L  | 2,75   | DINT901217LTB  | 3,78   |
| 12-L  | 1/2"   | DINT901221L  | 7,11   | DINT901221LTB  | 8,64   |
| 15-L  | 3/8"   | DINT901517L  | 6,36   | DINT901517LTB  | 8,37   |
| 15-L  | 1/2"   | DINT901521L  | 4,32   | DINT901521LTB  | 6,88   |
| 18-L  | 1/2"   | DINT901821L  | 6,38   | DINT901821LTB  | 9,00   |
| 22-L  | 3/4"   | DINT902227L  | 13,04  | DINT902227LTB  | 14,71  |
| 28-L  | 1"     | DINT902834L  | 23,01  | DINT902834LTB  | 24,65  |
| 35-L  | 1.1/4" | DINT903542L  | 31,70  | DINT903542LTB  | 38,19  |
| 42-L  | 1.1/2" | DINT904249L  | 44,67  | DINT904249LTB  | 52,93  |
| 6-S   | 1/4"   | DINT900613S  | 4,82   | DINT900613STB  | 6,05   |
| 8-S   | 1/4"   | DINT900813S  | 5,50   | DINT900813STB  | 6,80   |
| 8-S   | 3/8"   |              |        |                |        |
| 8-S   | 1/2"   |              |        |                |        |
| 10-S  | 1/4"   |              |        |                |        |
| 10-S  | 3/8"   | DINT901017S  | 6,24   | DINT901017STB  | 7,85   |
| 10-S  | 1/2"   |              |        |                |        |
| 12-S  | 3/8"   | DINT901217S  | 4,28   | DINT901217STB  | 5,70   |
| 12-S  | 1/2"   | DINT901221S  | 6,36   | DINT901221STB  | 8,04   |
| 14-S  | 1/2"   | DINT901421S  | 7,56   | DINT901421STB  | 9,68   |
| 16-S  | 1/2"   | DINT901621S  | 5,56   | DINT901621STB  | 8,18   |
| 20-S  | 3/4"   | DINT902027S  | 8,82   | DINT902027STB  | 15,44  |
| 25-S  | 1"     | DINT902534S  | 20,17  | DINT902534STB  | 24,85  |
| 30-S  | 1.1/4" | DINT903042S  | 43,84  | DINT903042STB  | 50,85  |
| 38-S  | 1.1/2" | DINT903849S  | 63,88  |                |        |



## UNIONES NPT - UNF



UNION MACHO NPT

| CUERPO | COMPLETA |
|--------|----------|
|--------|----------|

| TUBO | NPT    | CODIGO    | TARIFA | CODIGO       | TARIFA |
|------|--------|-----------|--------|--------------|--------|
| 4-LL | 1/8"   |           |        | DINN0410LLTB |        |
| 6-LL | 1/8"   |           |        | DINN0610LLTB | 2,44   |
| 8-LL | 1/8"   |           |        | DINN0810LLTB | 3,57   |
| 6-L  | 1/8"   | DINN0610L | 1,45   | DINN0610L    | 2,64   |
| 6-L  | 1/4"   | DINN0613L | 1,88   | DINN0613L    | 3,06   |
| 6-L  | 3/8"   |           |        |              |        |
| 8-L  | 1/8"   |           |        |              |        |
| 8-L  | 1/4"   | DINN0813L | 1,79   | DINN0813L    | 2,95   |
| 8-L  | 3/8"   |           |        |              |        |
| 8-L  | 1/2"   |           |        |              |        |
| 10-L | 1/4"   | DINN1013L | 2,39   | DINN1013L    | 3,77   |
| 10-L | 3/8"   |           |        | DINN1017L    | 4,26   |
| 10-L | 1/2"   |           |        |              |        |
| 12-L | 1/4"   | DINN1213L | 1,72   | DINN1213L    | 3,25   |
| 12-L | 3/8"   | DINN1217L | 2,30   | DINN1217L    | 3,83   |
| 12-L | 1/2"   | DINN1221L | 3,52   | DINN1221L    | 5,05   |
| 15-L | 3/8"   |           |        |              |        |
| 15-L | 1/2"   | DINN1521L | 3,58   | DINN1521L    | 5,60   |
| 18-L | 1/2"   | DINN1821L | 3,81   | DINN1821L    | 6,62   |
| 18-L | 3/4"   |           |        |              |        |
| 22-L | 3/4"   | DINN2227L | 5,34   | DINN2227L    | 9,11   |
| 28-L | 1"     | DINN2834L | 13,63  | DINN2834L    | 16,65  |
| 35-L | 1.1/4" | DINN3542L | 25,66  | DINN3542L    | 29,30  |
| 42-L | 1.1/2" | DINN4249L | 30,93  | DINN4249L    | 40,10  |
| 6-S  | 1/8"   |           |        |              |        |
| 6-S  | 1/4"   | DINN0613S | 1,86   | DINN0613S    | 3,09   |
| 6-S  | 3/8"   |           |        |              |        |
| 8-S  | 1/4"   | DINN0813S | 2,50   | DINN0813S    | 3,79   |
| 8-S  | 3/8"   |           |        |              |        |
| 8-S  | 1/2"   |           |        |              |        |
| 10-S | 1/4"   | DINN1013S | 1,43   | DINN1013S    | 3,04   |
| 10-S | 3/8"   | DINN1017S | 2,82   | DINN1017S    | 4,43   |
| 10-S | 1/2"   |           |        |              |        |
| 12-S | 1/4"   |           |        |              |        |
| 12-S | 3/8"   | DINN1217S | 3,52   | DINN1217S    | 5,21   |
| 12-S | 1/2"   | DINN1221S | 3,15   | DINN1221S    | 4,84   |
| 14-S | 1/2"   | DINN1421S | 3,10   | DINN1421S    | 5,75   |
| 16-S | 1/2"   | DINN1621S | 4,11   | DINN1621S    | 6,93   |
| 16-S | 3/4"   |           |        |              |        |
| 20-S | 1/2"   |           |        |              |        |
| 20-S | 3/4"   | DINN2027S | 6,02   | DINN2027S    | 10,04  |
| 25-S | 1"     | DINN2534S | 9,72   | DINN2534S    | 14,48  |
| 30-S | 1.1/4" | DINN3042S | 24,37  | DINN3042S    | 32,16  |
| 38-S | 1.1/2" | DINN3849S | 34,70  | DINN3849S    | 44,68  |



CODIGO MACHO NPT

| CUERPO | COMPLETA |
|--------|----------|
|--------|----------|

| TUBO | NPT    | CODIGO      | TARIFA | CODIGO         | TARIFA |
|------|--------|-------------|--------|----------------|--------|
| 4-LL | 1/8"   |             |        | DINN900410LLTB | 8,64   |
| 6-LL | 1/8"   |             |        | DINN900610LLTB | 4,29   |
| 8-LL | 1/8"   |             |        | DINN900810LLTB | 9,33   |
| 6-L  | 1/8"   | DINN900610L | 2,60   | DINN900610L    | 3,24   |
| 6-L  | 1/4"   | DINN900613L | 4,70   | DINN900613L    | 4,82   |
| 8-L  | 1/4"   | DINN900813L | 4,70   | DINN900813L    | 4,81   |
| 10-L | 1/4"   | DINN901013L | 5,35   | DINN901013L    | 5,57   |
| 12-L | 1/4"   | DINN901213L | 6,18   | DINN901213L    | 6,41   |
| 12-L | 3/8"   | DINN901217L | 5,99   | DINN901217L    | 6,56   |
| 12-L | 1/2"   | DINN901221L | 8,36   | DINN901221L    | 8,29   |
| 15-L | 1/2"   | DINN901521L | 9,32   | DINN901521L    | 9,70   |
| 18-L | 1/2"   | DINN901821L | 10,41  | DINN901821L    | 11,75  |
| 22-L | 3/4"   | DINN902227L | 14,83  | DINN902227L    | 15,44  |
| 28-L | 1"     | DINN902834L | 23,01  | DINN902834L    | 23,52  |
| 35-L | 1.1/4" | DINN903542L | 43,84  | DINN903542L    | 42,36  |
| 42-L | 1.1/2" | DINN904249L | 63,88  | DINN904249L    | 61,72  |
| 6-S  | 1/4"   | DINN900613S | 7,60   | DINN900613S    | 7,58   |
| 8-S  | 1/4"   | DINN900813S | 8,96   | DINN900813S    | 8,71   |
| 10-S | 3/8"   | DINN901017S | 9,53   | DINN901017S    | 9,77   |
| 12-S | 3/8"   | DINN901217S | 7,13   | DINN901217S    | 7,43   |
| 14-S | 1/2"   | DINN901421S | 25,58  | DINN901421S    | 23,80  |
| 16-S | 1/2"   | DINN901621S | 10,14  | DINN901621S    | 11,21  |
| 20-S | 3/4"   | DINN902027S | 14,74  | DINN902027S    | 13,98  |
| 25-S | 1"     | DINN902534S | 21,80  | DINN902534S    | 23,55  |
| 30-S | 1.1/4" | DINN903042S | 43,84  | DINN903042S    | 43,36  |
| 38-S | 1.1/2" | DINN903849S | 63,88  | DINN903849S    | 62,35  |

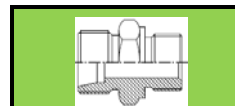

UNION MACHO UNF

CUERPO

| TUBO | UNF        | CODIGO    | TARIFA |
|------|------------|-----------|--------|
| 8-L  | 7/16 UNF   | DINU0408L | 2,25   |
| 10-L | 7/16 UNF   | DINU0410L | 2,72   |
| 12-L | 9/16 UNF   | DINU0612L | 12,61  |
| 12-L | 3/4 UNF    | DINU0812L | 13,92  |
| 12-L | 7/8 UNF    | DINU1012L | 4,55   |
| 15-L | 3/4 UNF    | DINU0815L | 4,71   |
| 18-L | 3/4 UNF    | DINU0818L | 4,54   |
| 18-L | 7/8 UNF    | DINU1018L | 4,44   |
| 22-L | 7/8 UNF    | DINU1022L | 16,98  |
| 22-L | 1 1/16 UNF | DINU1222L | 17,35  |
| 22-L | 1 5/16 UNF | DINU1622L | 21,27  |
| 28-L | 1 1/16 UNF | DINU1228L | 21,51  |
| 28-L | 1 5/16 UNF | DINU1628L | 21,61  |
| 35-L | 1 5/16 UNF | DINU1635L | 24,84  |
| 35-L | 1 5/8 UNF  | DINU2035L | 28,32  |
| 42-L | 1 5/8 UNF  | DINU2042L | 33,44  |
| 8-S  | 7/16 UNF   | DINU0408S | 11,87  |
| 8-S  | 3/4 UNF    | DINU0812S | 14,28  |
| 10-S | 9/16 UNF   | DINU0610S | 12,84  |
| 12-S | 9/16 UNF   | DINU0612S | 13,91  |
| 16-S | 3/4 UNF    | DINU0816S | 13,89  |
| 20-S | 3/4 UNF    | DINU0820S | 17,47  |
| 20-S | 7/8 UNF    | DINU1020S | 18,16  |
| 20-S | 1 1/16 UNF | DINU1220S | 19,01  |
| 25-S | 1 5/16 UNF | DINU1625S | 26,95  |
| 30-S | 1 5/16 UNF | DINU1630S | 32,85  |



## UNIONES METRICAS

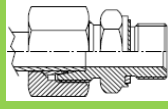
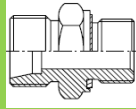

### UNION MACHO METRICA CON JUNTA

| TUBO | ROSCA    | CUERPO     |        | COMPLETA     |        |
|------|----------|------------|--------|--------------|--------|
|      |          | CODIGO     | TARIFA | CODIGO       | TARIFA |
| 6-L  | M.10*100 | DINM0610LJ | 1,70   | DINM0610LJTB | 2,88   |
| 8-L  | M.12*150 | DINM0812LJ | 2,19   | DINM0812LJTB | 3,34   |
| 10-L | M.14*150 | DINM1014LJ | 1,95   | DINM1014LJTB | 3,34   |
| 10-L | M.16*150 | DINM1016LJ | 3,05   | DINM1016LJTB | 4,44   |
| 10-L | M.18*150 | DINM1018LJ | 4,11   | DINM1018LJTB | 5,50   |
| 10-L | M.22*150 | DINM1022LJ | 4,67   |              |        |
| 12-L | M.16*150 | DINM1216LJ | 2,43   | DINM1216LJTB | 3,96   |
| 12-L | M.18*150 | DINM1218LJ | 3,60   |              |        |
| 12-L | M.22*150 | DINM1222LJ | 4,66   | DINM1222LJTB | 6,19   |
| 15-L | M.18*150 | DINM1518LJ | 3,64   | DINM1518LJTB | 5,66   |
| 15-L | M.22*150 | DINM1522LJ | 4,72   | DINM1522LJTB | 6,74   |
| 18-L | M.18*150 | DINM1818LJ | 12,24  |              |        |
| 18-L | M.22*150 | DINM1822LJ | 3,79   | DINM1822LJTB | 6,60   |
| 22-L | M.26*150 | DINM2226LJ | 7,28   | DINM2226LJTB | 11,05  |
| 28-L | M.33*2   | DINM2833LJ | 9,72   | DINM2833LJTB | 13,23  |
| 35-L | M.42*2   | DINM3542LJ | 16,76  | DINM3542LJTB | 24,06  |
| 42-L | M.48*2   | DINM4248LJ | 27,71  | DINM4248LJTB | 36,88  |
| 6-S  | M.12*150 | DINM0612SJ | 1,76   | DINM0612SJT  | 2,99   |
| 6-S  | M.14*150 |            |        |              |        |
| 8-S  | M.14*150 | DINM0814SJ | 2,61   |              |        |
| 10-S | M.16*150 | DINM1016SJ | 2,54   | DINM1016SJT  | 4,15   |
| 10-S | M.14*150 |            |        |              |        |
| 12-S | M.18*150 | DINM1218SJ | 3,90   | DINM1218SJT  | 5,59   |
| 14-S | M.20*150 | DINM1420SJ | 3,41   | DINM1420SJT  | 6,06   |
| 16-S | M.22*150 | DINM1622SJ | 5,08   | DINM1622SJT  | 7,91   |
| 20-S | M.27*2   | DINM2027SJ | 8,09   |              |        |
| 25-S | M.33*2   | DINM2533SJ | 8,88   | DINM2533SJT  | 13,75  |
| 30-S | M.42*2   | DINM3042SJ | 13,56  | DINM3042SJT  | 22,32  |
| 38-S | M.48*2   | DINM3848SJ | 18,08  | DINM3848SJT  | 26,05  |

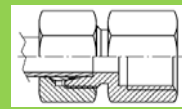
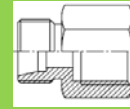

### HEMBRA MET

### HEMBRA MET

| TUBO | ROSCA    | HEMBRA MET COMPLETA |        | HEMBRA MET COMPLETA |        |
|------|----------|---------------------|--------|---------------------|--------|
|      |          | CODIGO              | TARIFA | CODIGO              | TARIFA |
| 6-L  | M.10*100 | DINMH0610L          | 10,38  | DINMH0610LTB        | 11,56  |
| 8-L  | M.12*150 | DINMH0812L          | 11,35  | DINMH0812LTB        | 12,50  |
| 10-L | M.14*150 | DINMH1014L          | 12,23  | DINMH1014LTB        | 13,62  |
| 10-L | M.16*150 |                     |        |                     |        |
| 10-L | M.18*150 |                     |        |                     |        |
| 10-L | M.22*150 |                     |        |                     |        |
| 12-L | M.16*150 | DINMH1216L          | 13,41  | DINMH1216LTB        | 14,94  |
| 12-L | M.18*150 |                     |        |                     |        |
| 12-L | M.22*150 |                     |        |                     |        |
| 15-L | M.18*150 | DINMH1518L          | 14,77  | DINMH1518LTB        | 14,69  |
| 15-L | M.22*150 |                     |        |                     |        |
| 18-L | M.18*150 |                     |        |                     |        |
| 18-L | M.22*150 | DINMH1822L          | 15,93  | DINMH1822LTB        | 18,40  |
| 22-L | M.26*150 | DINMH2226L          | 16,90  | DINMH2226LTB        | 20,20  |
| 28-L | M.33*2   |                     |        |                     |        |
| 35-L | M.42*2   |                     |        |                     |        |
| 42-L | M.48*2   |                     |        |                     |        |
| 6-S  | M.12*150 | DINMH0612S          | 11,41  | DINMH0612STB        | 12,65  |
| 6-S  | M.14*150 |                     |        |                     |        |
| 8-S  | M.14*150 | DINMH0814S          | 12,31  | DINMH0814STB        | 13,61  |
| 10-S | M.16*150 | DINMH1016S          | 13,47  | DINMH1016STB        | 13,20  |
| 10-S | M.14*150 |                     |        |                     |        |
| 12-S | M.18*150 | DINMH1218S          | 14,45  | DINMH1218STB        | 14,12  |
| 14-S | M.20*150 | DINMH1420S          | 13,74  | DINMH1420STB        | 16,06  |
| 16-S | M.22*150 |                     |        |                     |        |
| 20-S | M.27*2   | DINMH2027S          | 18,93  | DINMH2027STB        | 22,45  |
| 25-S | M.33*2   |                     |        |                     |        |
| 30-S | M.42*2   |                     |        |                     |        |
| 38-S | M.48*2   |                     |        |                     |        |

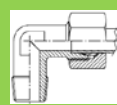
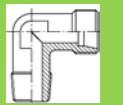

### CODO 90° METRICA CONICA

| TUBO | ROSCA    | CUERPO       |        | COMPLETA       |        |
|------|----------|--------------|--------|----------------|--------|
|      |          | CODIGO       | TARIFA | CODIGO         | TARIFA |
| 4-LL | M.8*100  | DINM900408LL | 3,28   | DINM900408LLTB | 4,36   |
| 6-LL | M.10*100 | DINM900610LL | 3,56   | DINM900610LLTB | 4,66   |
| 8-LL | M.10*100 | DINM900810LL | 4,20   | DINM900810LLTB | 5,44   |
| 6-L  | M.10*100 | DINM900610L  | 4,64   | DINM900610LTB  | 5,82   |
| 8-L  | M.12*150 |              |        | DINM900812LTB  | 6,07   |
| 10-L | M.14*150 |              |        | DINM901014LTB  | 7,52   |
| 12-L | M.16*150 | DINM901216L  | 6,96   | DINM901216LTB  | 8,49   |
| 15-L | M.18*150 | DINM901518L  | 9,33   | DINM901518LTB  | 11,35  |
| 18-L | M.22*150 |              |        |                |        |
| 22-L | M.26*150 |              |        |                |        |
| 6-S  | M.12*150 | DINM900612S  | 24,93  | DINM900612STB  | 26,01  |
| 8-S  | M.14*150 | DINM901408S  | 25,56  | DINM901408STB  | 23,73  |
| 10-S | M.16*150 | DINM901610S  | 7,02   | DINM901610STB  | 8,62   |
| 12-S | M.18*150 |              |        |                |        |
| 14-S | M.20*150 | DINM902014S  | 25,56  | DINM902014STB  | 27,62  |
| 16-S | M.22*150 | DINM902216S  | 29,21  | DINM902216STB  | 31,41  |

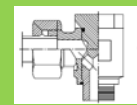

### CODO BANJO METRICO

| TUBO | ROSCA    | CUERPO        |        | COMPLETA        |        |
|------|----------|---------------|--------|-----------------|--------|
|      |          | CODIGO        | TARIFA | CODIGO          | TARIFA |
| 6-LL | M.10*100 | DINMBAE0610LL | 13,34  | DINMBAE0610LLTB | 14,43  |
| 8-LL | M.10*100 | DINMBAE0810LL | 13,34  | DINMBAE0810LLTB | 14,58  |
| 6-L  | M.10*100 | DINMBAE0610L  | 13,34  | DINMBAE0610LTB  | 14,52  |
| 8-L  | M.12*150 | DINMBAE0812L  | 15,50  | DINMBAE0812LTB  | 16,51  |
| 10-L | M.14*150 | DINMBAE1014L  | 15,50  | DINMBAE1014LTB  | 16,71  |
| 12-L | M.16*150 | DINMBAE1216L  | 21,08  | DINMBAE1216LTB  | 22,42  |
| 15-L | M.18*150 | DINMBAE1518L  | 23,78  | DINMBAE1518LTB  | 25,35  |
| 18-L | M.22*150 | DINMBAE1822L  | 26,04  | DINMBAE1822LTB  | 28,23  |
| 22-L | M.26*150 | DINMBAE2226L  | 42,18  | DINMBAE2226LTB  | 44,82  |
| 28-L | M.33*2   | DINMBAE2833L  | 73,75  | DINMBAE2833LTB  | 77,53  |
| 35-L | M.42*2   | DINMBAE3542L  | 122,33 | DINMBAE3542LTB  | 128,17 |
| 42-L | M.48*2   | DINMBAE4248L  | 155,80 | DINMBAE4248LTB  | 164,05 |
| 8-S  | M.14*150 | DINMBAE0814S  | 15,53  | DINMBAE0814STB  | 16,66  |
| 10-S | M.16*150 | DINMBAE1016S  | 21,10  | DINMBAE1016STB  | 22,51  |
| 12-S | M.18*150 | DINMBAE1218S  | 23,78  | DINMBAE1218STB  | 25,09  |
| 14-S | M.20*150 | DINMBAE1420S  |        |                 |        |
| 16-S | M.22*150 | DINMBAE1622S  | 26,04  | DINMBAE1622STB  | 28,24  |
| 20-S | M.27*2   | DINMBAE2027S  | 42,21  | DINMBAE2027STB  | 45,03  |
| 25-S | M.33*2   | DINMBAE2533S  | 73,75  | DINMBAE2533STB  | 78,53  |
| 30-S | M.42*2   | DINMBAE3042S  | 122,33 | DINMBAE3042STB  | 129,34 |
| 38-S | M.48*2   | DINMBAE3848S  | 155,80 | DINMBAE3848STB  | 164,78 |



## UNIONES ORIENTABLES

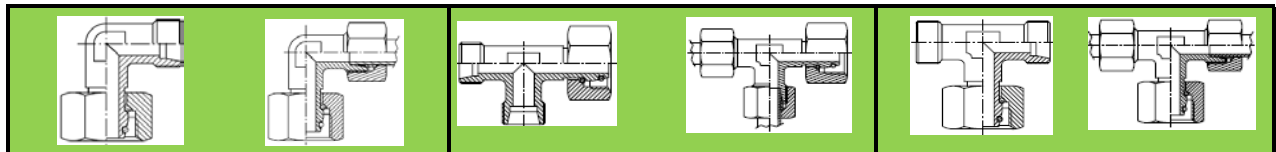

| RACOR EN CODO TUBO-TLOCA |          | TE ORIENTABLE LATERAL |          | TE ORIENTABLE CENTRAL |          |
|--------------------------|----------|-----------------------|----------|-----------------------|----------|
| CUERPO                   | COMPLETA | CUERPO                | COMPLETA | CUERPO                | COMPLETA |

| TUBO | CODIGO     | TARIFA | CODIGO       | TARIFA | CODIGO    | TARIFA | CODIGO      | TARIFA | CODIGO    | TARIFA |             |       |
|------|------------|--------|--------------|--------|-----------|--------|-------------|--------|-----------|--------|-------------|-------|
| 6-L  | DINTB9006L | 3,63   | DINTB9006LTB | 4,62   | DINITL06L | 7,12   | DINITL06LTB | 9,49   | DINITC06L | 7,12   | DINITC06LTB | 9,49  |
| 8-L  | DINTB9008L | 4,24   | DINTB9008LTB | 5,42   | DINITL08L | 7,41   | DINITL08LTB | 9,72   | DINITC08L | 7,41   | DINITC08LTB | 9,72  |
| 10-L | DINTB9010L | 3,67   | DINTB9010LTB | 5,10   | DINITL10L | 7,58   | DINITL10LTB | 10,35  | DINITC10L | 7,58   | DINITC10LTB | 10,35 |
| 12-L | DINTB9012L | 4,13   | DINTB9012LTB | 5,13   | DINITL12L | 8,91   | DINITL12LTB | 11,97  | DINITC12L | 8,87   | DINITC12LTB | 11,93 |
| 15-L | DINTB9015L | 5,62   | DINTB9015LTB | 8,08   | DINITL15L | 11,49  | DINITL15LTB | 13,59  | DINITC15L | 11,49  | DINITC15LTB | 13,59 |
| 18-L | DINTB9018L | 7,49   | DINTB9018LTB | 9,72   | DINITL18L | 14,46  | DINITL18LTB | 17,58  | DINITC18L | 14,45  | DINITC18LTB | 19,38 |
| 22-L | DINTB9022L | 10,31  | DINTB9022LTB | 14,88  | DINITL22L | 18,69  | DINITL22LTB | 25,29  | DINITC22L | 17,63  | DINITC22LTB | 24,22 |
| 28-L | DINTB9028L | 13,79  | DINTB9028LTB | 17,20  | DINITL28L | 28,41  | DINITL28LTB | 36,81  | DINITC28L | 29,82  | DINITC28LTB | 38,22 |
| 35-L | DINTB9035L | 37,49  | DINTB9035LTB | 43,98  | DINITL35L | 36,71  | DINITL35LTB | 44,72  | DINITC35L | 36,71  | DINITC35LTB | 44,72 |
| 42-L | DINTB9042L | 52,52  | DINTB9042LTB | 60,78  | DINITL42L | 51,62  | DINITL42LTB | 68,12  | DINITC42L | 51,62  | DINITC42LTB | 68,12 |
| 6-S  | DINTB9006S | 6,29   | DINTB9006STB | 7,53   | DINITL06S | 7,89   | DINITL06STB | 10,36  | DINITC06S | 8,11   | DINITC06STB | 10,58 |
| 8-S  | DINTB9008S | 7,08   | DINTB9008STB | 8,38   | DINITL08S | 8,41   | DINITL08STB | 11,00  | DINITC08S | 8,38   | DINITC08STB | 10,98 |
| 10-S | DINTB9010S | 4,32   | DINTB9010STB | 7,05   | DINITL10S | 11,80  | DINITL10STB | 13,14  | DINITC10S | 11,80  | DINITC10STB | 13,14 |
| 12-S | DINTB9012S | 4,69   | DINTB9012STB | 7,44   | DINITL12S | 12,42  | DINITL12STB | 13,81  | DINITC12S | 11,03  | DINITC12STB | 14,40 |
| 14-S | DINTB9014S | 5,45   | DINTB9014STB | 9,86   | DINITL14S | 13,38  | DINITL14STB | 18,02  | DINITC14S | 11,80  | DINITC14STB | 14,96 |
| 16-S | DINTB9016S | 7,88   | DINTB9016STB | 11,93  | DINITL16S | 14,00  | DINITL16STB | 18,95  | DINITC16S | 14,45  | DINITC16STB | 19,40 |
| 20-S | DINTB9020S | 10,31  | DINTB9020STB | 13,83  | DINITL20S | 18,72  | DINITL20STB | 25,76  | DINITC20S | 19,27  | DINITC20STB | 23,39 |
| 25-S | DINTB9025S | 14,26  | DINTB9025STB | 22,99  | DINITL25S | 32,12  | DINITL25STB | 42,74  | DINITC25S | 32,12  | DINITC25STB | 42,74 |
| 30-S | DINTB9030S | 23,52  | DINTB9030STB | 31,17  | DINITL30S | 40,07  | DINITL30STB | 50,09  | DINITC30S | 41,29  | DINITC30STB | 51,19 |
| 38-S | DINTB9038S |        | DINTB9038STB | 62,52  | DINITL38S | 58,40  | DINITL38STB | 76,37  | DINITC38S | 72,03  | DINITC38STB | 90,00 |

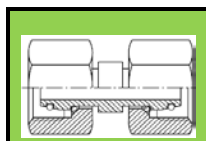

**UNION  
TUERCA LOCA DIN**

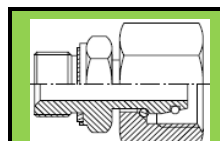

**MACHO METRICA  
TUERCA LOCA DIN**

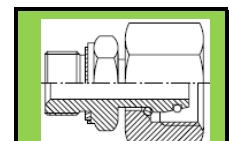

**MACHO BSPP  
TUERCA LOCA DIN**

| TUBO | CODIGO   | TARIFA | TUBO METRICA | CODIGO      | TARIFA |
|------|----------|--------|--------------|-------------|--------|
| 6-L  | DINGG06L | 10,93  | 6-L 10*1     | DINMG0610LJ | 13,10  |
| 8-L  | DINGG08L | 5,00   | 8-L 12*1,5   | DINMG0812LJ | 14,51  |
| 10-L | DINGG10L | 5,70   | 10-L 14*1,5  | DINMG1014LJ | 14,22  |
| 12-L | DINGG12L | 6,78   | 12-L 16*1,5  | DINMG1216LJ | 16,11  |
| 15-L | DINGG15L | 8,76   | 15-L 18*1,5  | DINMG1518LJ | 17,23  |
| 18-L | DINGG18L | 11,08  | 18-L 22*1,5  | DINMG1822LJ | 19,24  |
| 22-L | DINGG22L | 19,53  | 22-L 26*1,5  | DINMG2226LJ | 24,66  |
| 28-L | DINGG28L | 23,92  | 28-L 33*2    | DINMG2833LJ | 31,27  |
| 35-L | DINGG35L | 32,38  | 35-L 42*2    | DINMG3542LJ | 43,00  |
| 42-L | DINGG42L | 46,43  | 42-L 48*2    | DINMG4248LJ | 57,59  |
| 6-S  | DINGG06S | 11,50  | 6-S 12*1,5   | DINMG0612SJ | 14,23  |
| 8-S  | DINGG08S | 12,64  | 8-S 14*1,5   | DINMG0814SJ | 14,53  |
| 10-S | DINGG10S | 14,02  | 10-S 16*1,5  | DINMG1016SJ | 16,45  |
| 12-S | DINGG12S | 13,25  | 12-S 18*1,5  | DINMG1218SJ | 17,63  |
| 14-S | DINGG14S | 15,21  | 14-S 20*1,5  | DINMG1420SJ | 20,48  |
| 16-S | DINGG16S | 10,73  | 16-S 22*1,5  | DINMG1622SJ | 16,54  |
| 20-S | DINGG20S | 20,60  | 20-S 27*2    | DINMG2027SJ | 24,59  |
| 25-S | DINGG25S | 23,86  | 25-S 33*2    | DINMG2533SJ | 28,05  |
| 30-S | DINGG30S | 35,47  | 30-S 42*2    | DINMG3042SJ | 46,55  |
| 38-S | DINGG38S | 48,23  | 38-S 48*2    | DINMG3848SJ | 62,54  |

| TUBO | BSPP  | CODIGO      | TARIFA |
|------|-------|-------------|--------|
| 6-L  | 1/8   | DINPG0610LJ | 3,09   |
| 8-L  | 1/4   | DINPG0813LJ | 3,68   |
| 10-L | 1/4   | DINPG1013LJ | 4,82   |
| 12-L | 1/4   | DINPG1213LJ | 7,86   |
| 12-L | 3/8   | DINPG1217LJ | 4,68   |
| 15-L | 1/2   | DINPG1521LJ | 5,88   |
| 18-L | 1/2   | DINPG1821LJ | 6,14   |
| 22-L | 3/4   | DINPG2227LJ | 7,53   |
| 28-L | 1"    | DINPG2834LJ | 13,06  |
| 35-L | 1.1/4 | DINPG3542LJ | 21,82  |
| 42-L | 1.1/2 | DINPG4249LJ | 27,72  |
| 6-S  | 1/4   | DINPG0613SJ | 3,65   |
| 8-S  | 1/4   | DINPG0813SJ | 3,88   |
| 10-S | 3/8   | DINPG1017SJ | 3,79   |
| 12-S | 3/8   | DINPG1217SJ | 5,09   |
| 14-S | 1/2   | DINPG1421SJ | 5,59   |
| 16-S | 1/2   | DINPG1621SJ | 6,36   |
| 20-S | 3/4   | DINPG2027SJ | 9,62   |
| 25-S | 1"    | DINPG2534SJ | 14,55  |
| 30-S | 1.1/4 | DINPG3042SJ | 24,63  |
| 38-S | 1.1/2 | DINPG3849SJ | 35,14  |



## UNIONES SOLDABLES Y ANTIRRETORNOS

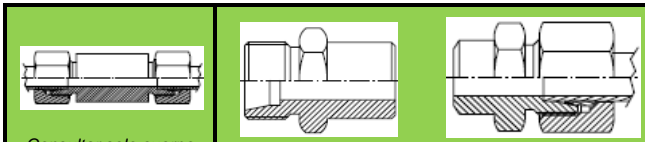

Consultar solo cuerpo

**PAS. SOLDAR****RACOR RECTO SOLDAR****COMPLETA****CUERPO****COMPLETA**

| TUBO | CODIGO      | TARIFA | CODIGO   | TARIFA | CODIGO     | TARIFA |
|------|-------------|--------|----------|--------|------------|--------|
| 6-L  | DINIWS06LTB | 18,65  | DINAS06L | 1,40   | DINAS06LTB | 2,58   |
| 8-L  | DINIWS08LTB | 18,25  | DINAS08L | 1,57   | DINAS08LTB | 2,73   |
| 10-L | DINIWS10LTB | 22,51  | DINAS10L | 1,77   | DINAS10LTB | 3,16   |
| 12-L | DINIWS12LTB | 20,56  | DINAS12L | 1,79   | DINAS12LTB | 3,32   |
| 15-L | DINIWS15LTB | 24,45  | DINAS15L | 2,06   | DINAS15LTB | 4,08   |
| 18-L | DINIWS18LTB | 29,25  | DINAS18L | 3,05   | DINAS18LTB | 5,87   |
| 22-L | DINIWS22LTB | 28,74  | DINAS22L | 4,96   | DINAS22LTB | 8,73   |
| 28-L | DINIWS28LTB | 31,71  | DINAS28L | 8,26   | DINAS28LTB | 13,66  |
| 35-L | DINIWS35LTB | 44,55  | DINAS35L | 11,13  | DINAS35LTB | 17,04  |
| 42-L | DINIWS42LTB | 58,85  | DINAS42L | 15,43  | DINAS42LTB | 25,75  |
| 6-S  | DINIWS06STB | 19,20  | DINAS06S | 11,13  | DINAS06STB | 12,36  |
| 8-S  | DINIWS08STB | 22,93  | DINAS08S | 11,88  | DINAS08STB | 13,18  |
| 10-S | DINIWS10STB | 21,19  | DINAS10S | 5,22   | DINAS10STB | 6,82   |
| 12-S | DINIWS12STB | 24,16  | DINAS12S | 6,58   | DINAS12STB | 8,26   |
| 14-S | DINIWS14STB | 29,66  | DINAS14S | 2,85   | DINAS14STB | 5,50   |
| 16-S | DINIWS16STB | 26,23  | DINAS16S | 3,72   | DINAS16STB | 6,55   |
| 20-S | DINIWS20STB | 28,52  | DINAS20S | 5,16   | DINAS20STB | 9,19   |
| 25-S | DINIWS25STB | 42,49  | DINAS25S | 9,58   | DINAS25STB | 14,36  |
| 30-S | DINIWS30STB | 49,81  | DINAS30S | 11,50  | DINAS30STB | 18,83  |
| 38-S | DINIWS38STB | 63,16  | DINAS38S | 16,30  | DINAS38STB | 24,47  |

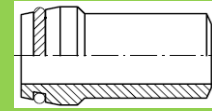
**PUNTA SOLDAR**

| TUBO        | CODIGO       | TARIFA |
|-------------|--------------|--------|
| 15-L 15x2,5 | DINASP15L    | 5,02   |
| 18-L 18x2,5 | DINASP18L    | 5,80   |
| 22-L 22x2,5 | DINASP22L    | 6,13   |
| 28-L 28x3   | DINASP28L    | 7,69   |
| 8-S 8x1,5   | DINASP08S150 | 1,70   |
| 10-S 10x2   | DINASP10S200 | 1,84   |
| 12-S 12x2,5 | DINASP12S    | 2,12   |
| 12-S 14x2   | DINASP14S200 | 6,32   |
| 14-S 14x3   | DINASP14S300 | 13,22  |
| 16-S 16x2   | DINASP16S200 | #N/A   |
| 16-S 16x3   | DINASP16S300 | 3,39   |
| 20-S 20x2,5 | DINASP20S250 | 8,95   |
| 20-S 20x3   | DINASP20S300 | 8,95   |
| 20-S 22x4   | DINASP20S400 | 3,82   |
| 25-S 25x4   | DINASP25S400 | 5,10   |
| 30-S 30x4   | DINASP30S400 | 14,83  |
| 30-S 30x5   | DINASP30S500 | 7,16   |
| 38-S 38x5   | DINASP38S500 | 12,02  |

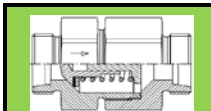
**ANTIRRETORNO TUBO->TUBO CUERPO**

| TUBO | CODIGO    | TARIFA |
|------|-----------|--------|
| 6-L  | DINIVA06L | 25,77  |
| 8-L  | DINIVA08L | 23,83  |
| 10-L | DINIVA10L | 28,28  |
| 12-L | DINIVA12L | 34,04  |
| 15-L | DINIVA15L | 38,41  |
| 18-L | DINIVA18L | 48,69  |
| 22-L | DINIVA22L | 68,65  |
| 28-L | DINIVA28L | 118,60 |
| 35-L | DINIVA35L | 174,19 |
| 42-L | DINIVA42L | 432,27 |
| 6-S  | DINIVA06S | 26,13  |
| 8-S  | DINIVA08S | 23,33  |
| 10-S | DINIVA10S | 28,74  |
| 12-S | DINIVA12S | 33,32  |
| 14-S | DINIVA14S | 40,23  |
| 16-S | DINIVA16S | 45,13  |
| 20-S | DINIVA20S | 57,42  |
| 25-S | DINIVA25S | 88,64  |
| 30-S | DINIVA30S | 167,54 |
| 38-S | DINIVA38S |        |

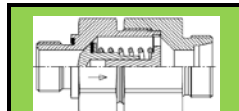
**ANTIRRETORNO ROSCA->TUBO CUERPO**

| ROSCA  | TUBO | CODIGO        | TARIFA |
|--------|------|---------------|--------|
| 1/8    | 6-L  | DINPVART1006L | 26,04  |
| 1/4    | 8-L  | DINPVART1308L | 25,51  |
| 1/4    | 10-L | DINPVART1310L | 29,24  |
| 3/8    | 12-L | DINPVART1712L | 35,48  |
| 1/2    | 15-L | DINPVART2115L | 40,22  |
| 1/2    | 18-L | DINPVART2118L | 50,85  |
| 3/4    | 22-L | DINPVART2722L | 75,69  |
| 1"     | 28-L | DINPVART3428L | 88,10  |
| 1.1/4" | 35-L | DINPVART4235L | 232,62 |
| 1.1/2" | 42-L | DINPVART4942L | 238,82 |
| 1/4    | 6-S  | DINPVART1306S | 26,00  |
| 1/4    | 8-S  | DINPVART1308S | 26,10  |
| 3/8    | 10-S | DINPVART1710S | 29,34  |
| 3/8    | 12-S | DINPVART1712S | 34,76  |
| 1/2    | 14-S | DINPVART2114S | 41,80  |
| 1/2    | 16-S | DINPVART2116S | 46,43  |
| 3/4    | 20-S | DINPVART2720S | 58,94  |
| 1"     | 25-S | DINPVART3425S | 89,94  |
| 1.1/4" | 30-S | DINPVART4230S |        |
| 1.1/2" | 38-S | DINPVART4938S |        |

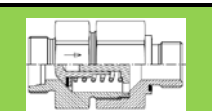
**ANTIRRETORNO TUBO->ROSCA CUERPO**

| TUBO | ROSCA  | CODIGO        | TARIFA |
|------|--------|---------------|--------|
| 6-L  | 1/8    | DINPVATR06L10 | 23,27  |
| 8-L  | 1/4    | DINPVATR08L13 | 25,03  |
| 10-L | 1/4    | DINPVATR10L13 | 29,24  |
| 12-L | 3/8    | DINPVATR12L17 | 34,52  |
| 15-L | 1/2    | DINPVATR15L21 | 38,89  |
| 18-L | 1/2    | DINPVATR18L21 | 49,12  |
| 22-L | 3/4    | DINPVATR22L27 | 78,08  |
| 28-L | 1"     | DINPVATR28L34 | 90,75  |
| 35-L | 1.1/4" | DINPVATR35L42 |        |
| 42-L | 1.1/2" | DINPVATR42L49 |        |
| 6-S  | 1/4    | DINPVATR06S13 | 23,59  |
| 8-S  | 1/4    | DINPVATR08S13 | 23,69  |
| 10-S | 3/8    | DINPVATR10S17 | 29,34  |
| 12-S | 3/8    | DINPVATR12S17 | 34,28  |
| 14-S | 1/2    | DINPVATR14S21 | 40,47  |
| 16-S | 1/2    | DINPVATR16S21 | 47,08  |
| 20-S | 3/4    | DINPVATR20S27 | 58,39  |
| 25-S | 1"     | DINPVATR25S34 | 89,19  |
| 30-S | 1.1/4" | DINPVATR30S42 |        |
| 38-S | 1.1/2" | DINPVATR38S49 |        |

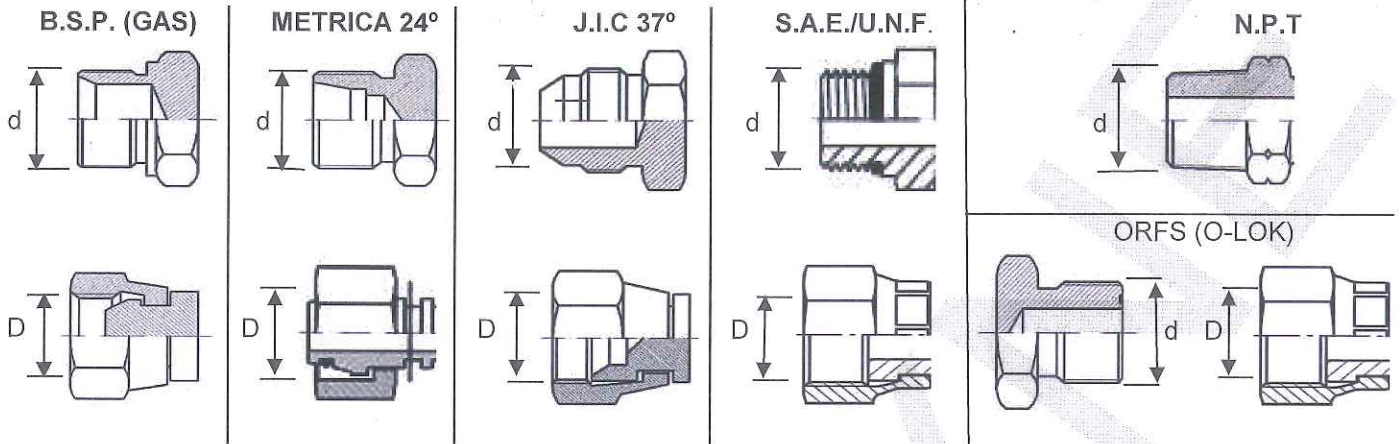

| mm.  | MACHO d           | HEMBRA D          |
|------|-------------------|-------------------|
| 6,9  |                   | METRICA 8x1       |
| 8    | METRICA 8x1       |                   |
| 8,4  |                   | JIC/SAE 3/8"-24   |
| 8,5  |                   | BSP 1/8"          |
| 8,9  |                   | METRICA 10x1      |
| 9,4  | JIC/SAE 3/8"-24   |                   |
| 9,7  | BSP 1/8"          |                   |
| 9,8  |                   | JIC/SAE 7/16"-20  |
| 10   | METRICA 10x1      |                   |
| 10,2 | NPT 1/8" -27      |                   |
| 10,3 |                   | METRICA 12x1,5    |
| 11   | JIC/SAE 7/16-20   |                   |
| 11,4 |                   | BSP 1/4"          |
| 11,4 |                   | JIC/SAE 1/2"-20   |
| 12   | METRICA 12x1,5    |                   |
| 12,3 |                   | METRICA 14x1,5    |
| 12,6 | JIC/SAE 1/2"-20   |                   |
| 12,8 |                   | JIC/SAE 9/16"-18  |
| 13,1 | BSP 1/4"          |                   |
| 13,7 | NPT 1/4"-18       |                   |
| 14   | METRICA 14x1,5    |                   |
| 14,2 | JIC/SAE 9/16"-18  |                   |
| 14,3 |                   | METRICA 16X1,5    |
| 14,9 |                   | BSP 3/8"          |
| 15,8 |                   | JIC/SAE 11/16"-16 |
| 16   | METRICA 16x1,5    |                   |
| 16,3 |                   | METRICA 18x1,5    |
| 16,6 | BSP 3/8"          |                   |
| 17,2 | NPT 3/8"-18       |                   |
| 17,4 | JIC/SAE 11/16"-16 | JIC/SAE 3/4"-16   |
| 18   | METRICA 18x1,5    |                   |
| 18,3 |                   | METRICA 20x1,5    |
| 18,6 |                   | BSP 1/2"          |
| 19   | JIC/SAE 3/4"16    | JIC/SAE 13/16"-16 |
| 20   | METRICA 20x1,5    |                   |
| 20,3 |                   | METRICA 22x1,5    |

| mm.  | MACHO d           | HEMBRA D          |
|------|-------------------|-------------------|
| 20,4 |                   | JIC/SAE 7/8-16    |
| 20,5 | JIC/SAE 13/16"-16 | BSP 5/8"          |
| 20,9 | BSP 1/2"          |                   |
| 21,3 | NPT 1/2"-14       |                   |
| 22   | METRICA 22x1,5    |                   |
| 22,1 | JIC/SAE 7/8"-14   |                   |
| 22,3 |                   | METRICA 24x1,5    |
| 22,9 | BSP 5/8"          |                   |
| 23,5 |                   | JIC/SAE 1"-14     |
| 24   | METRICA 24x1,5    |                   |
| 24,1 |                   | BSP 3/4"          |
| 24,3 |                   | METRICA 26x1,5    |
| 24,8 |                   | JIC/SAE 1"1/16-12 |
| 25,3 | JIC/SAE 1"-14     | METRICA 27x1,5    |
| 26   | METRICA 26x1,5    |                   |
| 26,4 | BSP 3/4"          |                   |
| 26,6 | NPT 3/4"-14       |                   |
| 26,9 | JIC/SAE 1"1/16-12 |                   |
| 27   | METRICA 27x1,5    |                   |
| 27,8 |                   | METRICA 30x2      |
| 28,1 |                   | JIC/SAE 1"3/16-12 |
| 28,3 |                   | METRICA 30x1,5    |
| 30   | METRICA 30x1,5    |                   |
| 30   | METRICA 30x2      |                   |
| 30,1 | JIC/SAE 1"3/16-12 |                   |
| 30,2 |                   | BSP 1"            |
| 30,3 |                   | METRICA 32x1,5    |
| 31,2 |                   | JIC/SAE 1"5/16-12 |
| 31,3 |                   | METRICA 33x1,5    |
| 32   | METRICA 32x1,5    |                   |
| 33   | METRICA 33x1,5    |                   |
| 33,2 | JIC/SAE 1"5/16-12 |                   |
| 33,2 | BSP 1"            |                   |
| 33,4 | NPT 1"-11,5       |                   |
| 33,8 |                   | METRICA 36s2      |
| 34,3 |                   | METRICA 36x1,5    |

| mm.  | MACHO d            | HEMBRA D           |
|------|--------------------|--------------------|
| 34,4 |                    | JIC/SAE 1"7/16-12  |
| 36   | METRICA 36x1,5     |                    |
| 36   | METRICA 36x2       |                    |
| 36,3 | JIC/SAE 1"7/16-12  | METRICA 38x1,5     |
| 38   | METRICA 38x1,5     |                    |
| 38,9 |                    | BSP 1"1/4          |
| 39,2 |                    | JIC/SAE 1"5/8-12   |
| 39,8 |                    | METRICA 42x2       |
| 40,7 |                    | JIC/SAE 1"11/16-12 |
| 41,2 | JIC/SAE 1"5/8-12   |                    |
| 41,9 | BSP 1"1/4          |                    |
| 42   | METRICA 42x2       |                    |
| 42,1 | NPT 1"1/4-11.5     |                    |
| 42,8 | JIC/SAE 1"11/16-12 | METRICA 45x2       |
| 43,3 |                    | METRICA 45x1,5     |
| 44,8 |                    | BSP 1"1/2          |
| 45   | METRICA 45x1,5     |                    |
| 45   | METRICA 45x2       |                    |
| 45,5 |                    | JIC/SAE 1"7/8-12   |
| 47,5 | JIC/SAE 1"7/8-12   |                    |
| 47,8 | BSP 1"1/2          |                    |
| 48,2 | NPT 1"1/2-11.5     |                    |
| 48,7 |                    | JIC/SAE 2"-12      |
| 49,8 |                    | METRICA 52x2       |
| 50,3 |                    | METRICA 52x1,5     |
| 50,7 | JIC/SAE 2"-12      |                    |
| 52   | METRICA 52x1,5     |                    |
| 52   | METRICA 52x2       |                    |
| 56,6 |                    | BSP 2"             |
| 59,6 | BSP 2"             |                    |
| 60,3 | NPT 2"-11.5        |                    |
| 61,4 |                    | JIC/SAE 2"1/2-12   |
| 62,8 |                    | METRICA 65x2       |
| 63,4 | JIC/SAE 2"1/2-12   |                    |
| 65   | METRICA 65x2       |                    |