

EGA Master ofrece una amplia gama de cortaaazulejos manuales diseñados para cortes rectos, angulares o circulares de cerámicas hasta 120cm de ancho.

EGA Master offers a wide range of tile cutters designed for straight, angular and circular ceramic cuts up to 120cm wide.

Ega Master offre une grande gamme de coupe carreaux manuels concus pour des coupes droites, angulaires ou circulaires pour des dimensions maximum de 120 cm

Todos ellos equipados con guías tubulares o macizas para lograr un corte más preciso y profesional, y provista de una bolsa de nylon para facilitar su transporte.

All of them equipped with tubular or solid guides for accurate and professional cuts, and provided with a nylon bag for their easy transport.

Tous sont équipés de guides tubulaires ou pleins pour obtenir une coupe plus précise et professionnelle, et présentés dans une poche en nylon pour faciliter le transport

0. Diseñado para realizar cortes rectos y angulares de cerámicas hasta 120cm.

Designed for straight and angular ceramic cutting up to 120cm.

Conçus pour réaliser des coupes droites ou angulaires de céramiques de 120 cm.

2. Rodamientos ajustables para un corte más preciso.

Adjustable bearings for accurate cutting.

Roulements ajustables pour une meilleure coupe.

4. Conjunto de escuadra giratoria con escala métrica y sistema de medición angular para cortes rectos de 0° a 45°.

Swivel square set with metric scale and angular measuring system for 0° to 45° straight cutting.

Système d'équerre rotative avec une graduation métrique pour des coupes de 0° à 45°.

1. Única guía maciza de acero para una mejor visión de rayado y corte.

One solid steel guide for better view of the scrapping and cutting process.

Un guide solide en acier pour une meilleure vue du marquage et une meilleure coupe.

3. Tope lateral para realizar cortes repetitivos rectos y a 45°.

Side stop for repetitive straight and 45° cutting.

Côte latérale pour faire des coupes droites et à 45° répétitives.

5. Base de aluminio con soportes laterales para un mejor apoyo de cerámicas de gran tamaño.

Aluminium base with movable large extension pads to stand larger ceramic sizes.

Base en aluminium avec des supports latéraux pour un meilleur appui de céramiques de grandes dimensions.

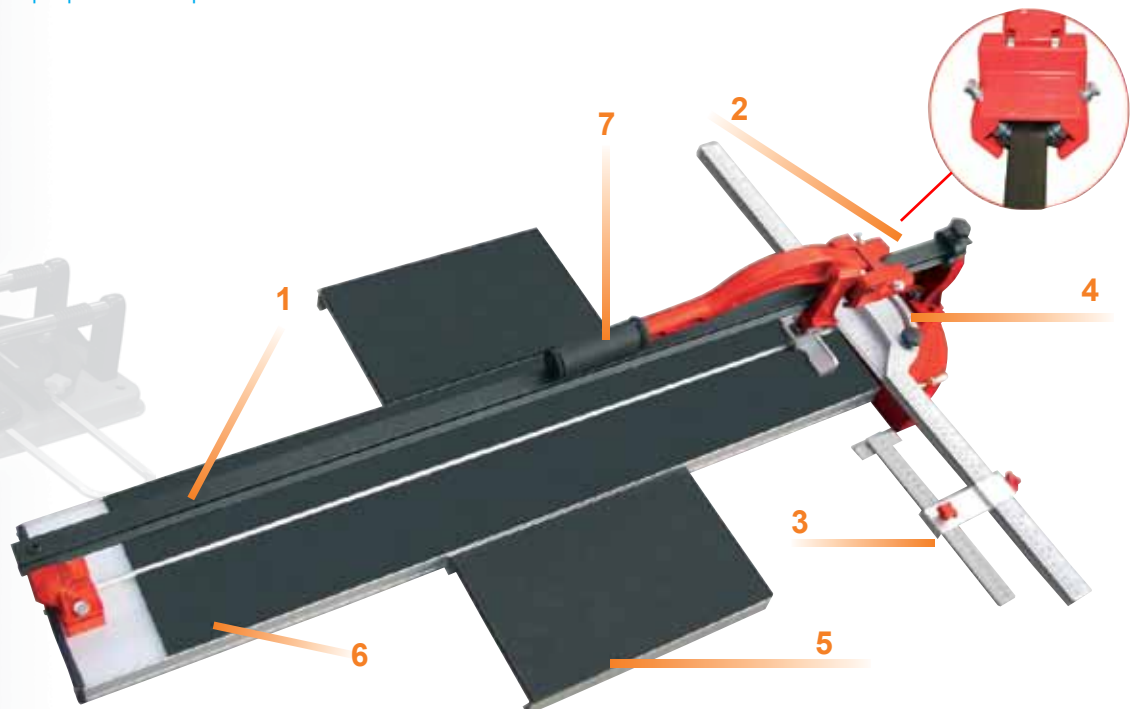

6. Base con efecto amortiguante para lograr cortes con máxima precisión.

Cushion effect base to get highest accuracy cuts.

Base avec effet amortisseur pour obtenir des coupes de grande précision.

7. Mango ergonómico para un fácil agarre y un uso confortable.

Ergonomic handle for easy gripping and comfortable use.

Manche ergonomique pour une meilleure prise et un usage facile.

CORTAAZULEJOS MANUALES / HAND TILE CUTTERS / COUPE CARREAUX MANUELS /
MANUELLER KACHELSCHNEIDER / TAGLIAPIASTRELLE / CORTA AZULEIJOS MANUAIS /
РУЧНОЙ ПЛИТКОРЕЗ

CLASSIC



| COD | | | | Kg. | |
|-------|------|--------|---|-----|-----------|
| 63922 | 40cm | 4-12mm | ● | 4,0 | 63943 |
| 63923 | 60cm | | | 5,0 | Ø22x6x2mm |

Especificaciones técnicas / Technical specification / Détails techniques

Guías tubulares de acero cromadas y rectificadas / Rectified and chromed steel tubular guides / Guides rectifiés en acire chromé

Con separador móvil / Adjustable breaking system / Avec séparateur mobile

Base con efecto amortiguante / Base with cushion effect / Base avec effet amortisseur

Visión directa de rayado y corte / Direct view of scrapping and cutting process / Vue directe du marquage et du processus de coupe

Tope lateral para realizar cortes repetitivos rectos y a 45° / Side limit for repetitive straight and 45° cuts / Câle latérale pour des coupes droites répétitives et des coupes à 45°

Cuchilla de carburo de tungsteno (WIDIA) / Tungsten carbide cutting wheel (WIDIA) / Lame en carbure de tungstène (WIDIA)



| COD | | | | | Kg. | |
|-------|------|--------|---------|---|-----|-----------|
| 63924 | 40cm | 4-12mm | 30-80mm | ● | 5,0 | 63943 |
| | | | | | | Ø22x6x2mm |

Especificaciones técnicas / Technical specification / Détails techniques

Guías tubulares de acero cromadas y rectificadas / Rectified and chromed steel tubular guides / Guides rectifiés en acire chromé

Con separador móvil / Adjustable breaking system / Avec séparateur mobile

Base con efecto amortiguante / Base with cushion effect / Base avec effet amortisseur

Visión directa de rayado y corte / Direct view of scrapping and cutting process / Vue directe du marquage et du processus de coupe

Tope lateral para realizar cortes repetitivos rectos / Side limit for repetitive straight cuts / Câle latérale pour des coupes droites répétitives

Sistema de medición angular para cortes rectos de 0 a 45° / Angular measuring system for 0 to 45° straight cutting / Système de mesure angulaire pour des coupes droites de 0° à 45°

Taladro para cortes circulares / Drill hole for circular cutting / Mèche pour des coupes circulaires

Cuchilla de carburo de tungsteno (WIDIA) / Tungsten carbide cutting wheel (WIDIA) / Lame en carbure de tungstène (WIDIA)

MASTER



| COD | | | | | Kg. | | |
|-------|-------|--------|---|--|-----|-------|------------|
| 63934 | 60cm | ≤ 16mm | ● | | 14 | 63947 | Ø20x14x6mm |
| 63935 | 70cm | | | | 15 | | |
| 63936 | 80cm | | | | 16 | | |
| 63937 | 90cm | | | | 17 | | |
| 63938 | 100cm | | | | 18 | | |
| 63939 | 120cm | | | | 20 | | |

Especificaciones técnicas / Technical specification / Détails techniques

Guía maciza de acero cromada y rectificada / Rectified and chromed steel solid guides / Guide robuste en acier chromé et rectifié

Con separador móvil / Adjustable breaking system / Avec séparateur mobile

Base con efecto amortiguante / Base with cushion effect / Base avec effet amortisseur

Visión directa de rayado y corte / Direct view of scrapping and cutting process / Vue directe du marquage et du processus de coupe

Tope lateral para realizar cortes repetitivos rectos y a 45° / Side limit for repetitive straight and 45° cuts / Câle latérale pour des coupes droites répétitives et des coupes à 45°

Conjunto de escuadra giratoria con escala métrica y sistema de medición angular para cortes rectos de 0 a 45° / Swivel square set with metric scale and angular measuring system for 0 to 45° straight cutting / Système d'équerre giratoire avec graduation métrique et système de mesure d'angle pour des coupes droites de 0° à 45°

Base de aluminio con soportes laterales móviles para un mejor apoyo de azulejos de gran tamaño / Aluminium base with movable large extension pads for support of the larger tile sizes / Base aluminium avec des support latéraux pour un meilleur appui des céramiques de grande dimension

Cuchilla de carburo de tungsteno (WIDIA) recubierta de nitruro de titanio (TiN) / Titanio (TiN) coated tungsten carbide (WIDIA) cutting wheel / Lame en carbure de tungstène (WIDIA) recouverte de nitrure de titane

EGMA Master S.A.

ART IN INNOVATION

PALAS / SHOVELS / PELLERES / SCHAUFELN / PALE / PAS / ЛОПАТКОУЛАВЛИВАТЕЛИ

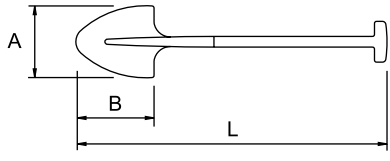
| COD | L | A | B | Kg. | |
|-------|------|-----|-----|-----|---|
| 67185 | 1030 | 265 | 325 | 1,9 | 6 |
| 67186 | 1030 | 285 | 335 | 1,9 | 6 |

| COD | L | A | B | Kg. | |
|-------|------|-----|-----|-----|---|
| 67187 | 1020 | 265 | 325 | 1,9 | 6 |
| 67188 | 1020 | 285 | 335 | 1,9 | 6 |

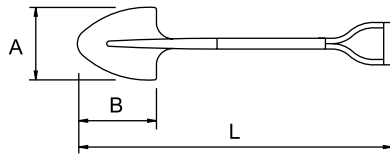
| COD | L | A | B | Kg. | |
|-------|------|-----|-----|-----|---|
| 67189 | 1400 | 265 | 325 | 1,9 | 6 |



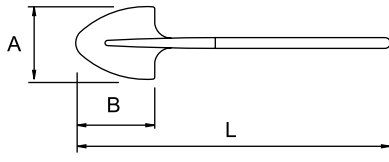

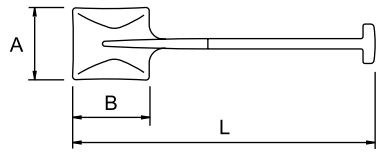
| COD | L | A | B | Kg. | |
|-------|------|-----|-----|-----|---|
| 67196 | 1020 | 250 | 325 | 1,8 | 6 |
| 67197 | 1020 | 265 | 340 | 1,9 | 6 |

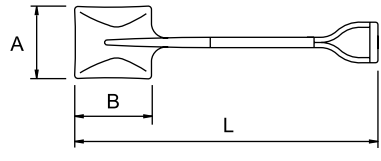
| COD | L | A | B | Kg. | |
|-------|------|-----|-----|-----|---|
| 67198 | 1020 | 250 | 325 | 2,1 | 6 |
| 67199 | 1020 | 265 | 340 | 2,1 | 6 |

PALAS / SHOVELS / PELLERES / SCHAUFELN / PALE / PAS / ЛОПАТКОУЛАВЛИВАТЕЛИ

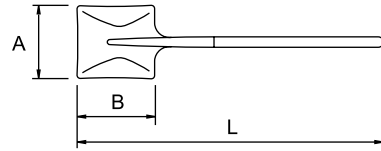

| COD | L | A | B | Kg. | |
|-------|------|-----|-----|-----|---|
| 67200 | 1400 | 250 | 325 | 2,0 | 6 |
| 67201 | 1400 | 265 | 340 | 2,0 | 6 |

ALUMINIUM

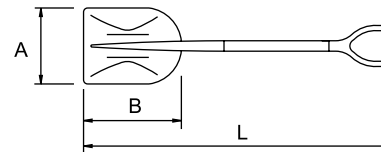

| COD | L | A | B | Kg. | |
|-------|------|-----|-----|-----|---|
| 67208 | 1300 | 345 | 390 | 1,6 | 6 |

ALUMINIUM

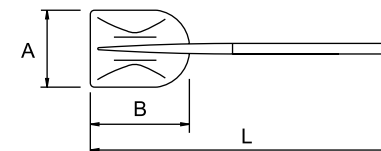

| COD | L | A | B | Kg. | |
|-------|------|-----|-----|-----|---|
| 67209 | 1620 | 345 | 390 | 1,6 | 6 |

ALUMINIUM

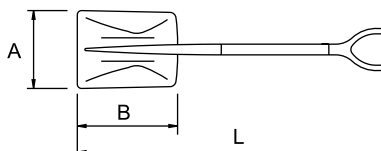

| COD | L | A | B | Kg. | |
|-------|-----|-----|-----|-----|---|
| 67212 | 990 | 260 | 305 | 0,9 | 6 |

PALAS / SHOVELS / PELLAS / SCHAUFELN / PALE / PAS / ЛОПАТКОУЛАВЛИВАТЕЛИ

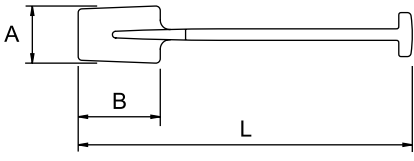
| COD | L | A | B | Kg. | Boxes |
|-------|-----|-----|-----|-----|-------|
| 67215 | 955 | 160 | 260 | 1,6 | 6 |

| COD | L | A | B | Kg. | Boxes |
|-------|-----|-----|-----|-----|-------|
| 67216 | 955 | 160 | 260 | 1,7 | 6 |

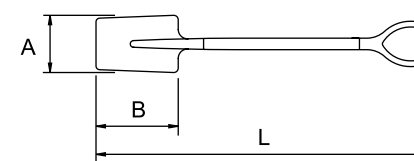
| COD | L | A | B | Kg. | Boxes |
|-------|------|-----|-----|-----|-------|
| 67218 | 1280 | 150 | 240 | 1,6 | 6 |

| COD | L | A | B | Kg. | Boxes |
|-------|------|-----|-----|-----|-------|
| 67219 | 1010 | 150 | 240 | 1,7 | 6 |

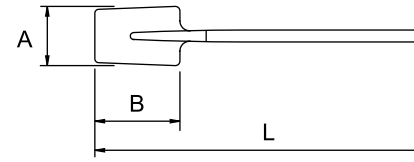
25 CONSTRUCCIÓN / CONSTRUCTION / CONSTRUCTION / BAUWESEN / COSTRUZIONI / CONSTRUÇÃO / СТРОИТЕЛЬСТВО

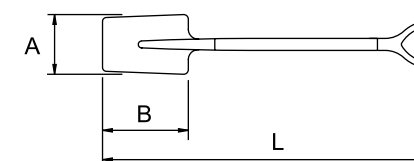
PALETAS / BRICKLAYERS / TRUELLES ET COUTEAUX / MAURERKELLEN / CAZZUOLE / COLHERES / МАСТЕРКИ

HOJA DE ACERO ESPECIAL, PULIDA Y TEMPLADA. MANGO BARNIZADO.
 ALLOY STEEL BLADE, POLISHED AND HARDENED. VARNISHED HANDLE.
 ACIER SPECIAL DOUBLEMENT POLI ET TREMPE. MANGHE VERNIE.
 KLINGE AUS SPEZIALSTAHL, PLANGESCHLIFFEN. POLIERT UND GEHÄRTET.
 ACCIAO SPECIALE LAMA PULITA IMPUGNATURA VERNICIATA.
 FOLHA DE AÇO ESPECIAL POLIDA E TEMPERADA CABO ENVERNIZADO.
 ПЛАСТИНА ИЗ СТАЛЬНОГО СПЛАВА, ДВОЙНАЯ ПОЛИРОВКА И ЗАКАЛКА, ЛАКИРОВАННАЯ РУКОЯТКА

| COD | A | B | gr. | | |
|-------|----|-----|-----|---|---|
| 67000 | 50 | 105 | 120 | | |
| 67001 | 70 | 130 | 135 | 6 | 1 |

| COD | A | B | gr. | | |
|-------|----|-----|-----|---|---|
| 67017 | 50 | 105 | 120 | | |
| 67002 | 70 | 130 | 135 | 6 | 1 |

| COD | A | B | C | gr. | | |
|-------|----|-----|-----|-----|---|---|
| 67004 | 87 | 180 | 115 | 340 | 6 | 1 |

MOD. CATALÁN

| COD | A | B | gr. | | |
|-------|-----|-----|-----|---|---|
| 67006 | 115 | 160 | 310 | | |
| 67005 | 122 | 170 | 320 | 6 | 1 |

MOD. MADRID

| COD | A | B | gr. | | |
|-------|-----|-----|-----|---|---|
| 67007 | 70 | 150 | 150 | | |
| 67008 | 85 | 165 | 175 | | |
| 67010 | 105 | 200 | 245 | 6 | 1 |
| 67019 | 115 | 230 | 290 | | |

MOD. ALICATADOR

| COD | A | B | C | gr. | | |
|-------|----|-----|-----|-----|---|---|
| 67012 | 65 | 120 | 120 | 280 | 6 | 1 |

MOD. PORTUGAL

| COD | A | B | C | gr. | | |
|-------|----|-----|-----|-----|---|---|
| 67013 | 65 | 250 | 130 | 280 | 6 | 1 |

| COD | A | B | C | gr. | | |
|-------|----|-----|-----|-----|---|---|
| 67015 | 56 | 220 | 120 | 390 | | |
| 67014 | 60 | 250 | 130 | 480 | 6 | 1 |

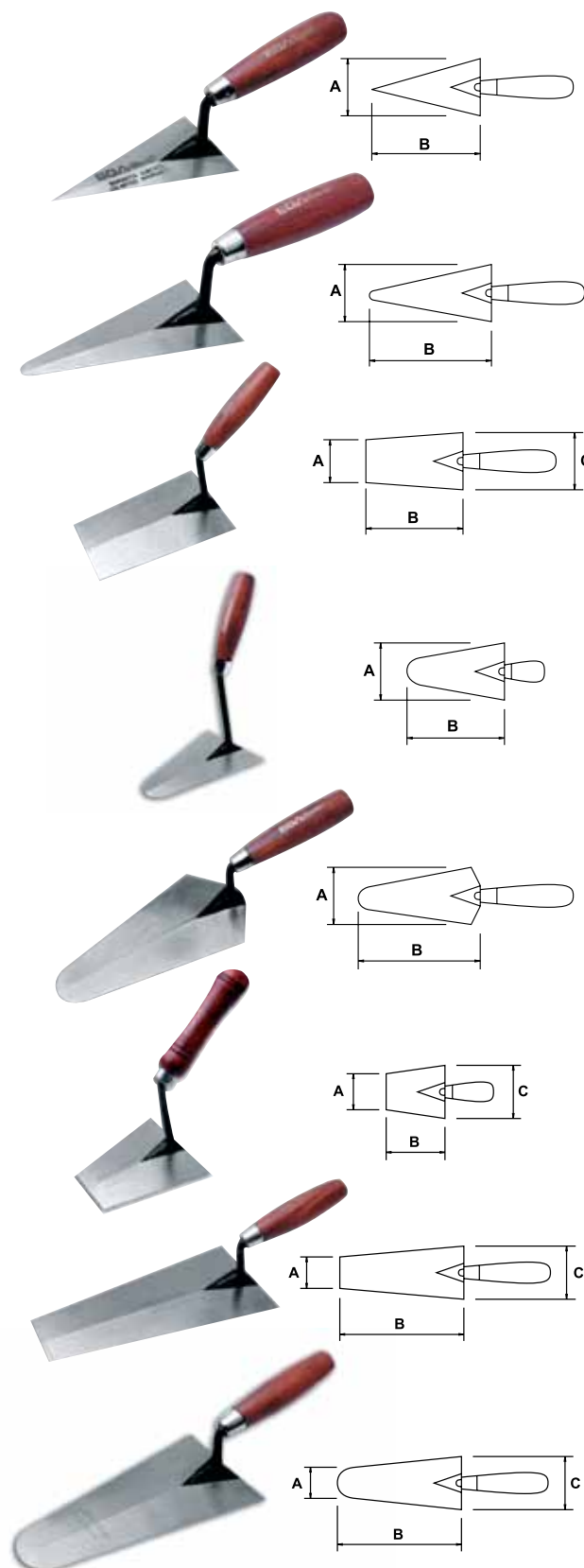

LLANAS / TROWELS / TRUELLE / KELLEN / FRATTONI / TALOCHAS / ПЛАДИКА

| COD | A | B | gr. | | |
|-------|-----|-----|-----|---|---|
| 67016 | 150 | 300 | 500 | 5 | 1 |

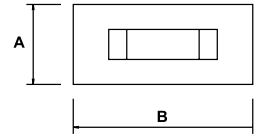

| COD | A | B | gr. | | |
|-------|-----|-----|-----|---|---|
| 67018 | 150 | 300 | 500 | 5 | 1 |

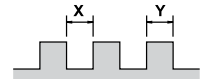
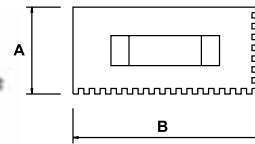

ESPÁTULAS / SCRAPERS / SPATULE / SCHABER / SPATOLE / ESPÁTULAS / ШПАТЕЛЬ

| COD | A | B | gr. | | |
|-------|-----|-----|-----|----|---|
| 67020 | 30 | 230 | 65 | 12 | 1 |
| 67021 | 40 | | | | |
| 67022 | 50 | | | | |
| 67023 | 60 | | | | |
| 67024 | 70 | 235 | 75 | 12 | 1 |
| 67025 | 80 | | | | |
| 67026 | 90 | | | | |
| 67027 | 100 | 250 | 90 | | |

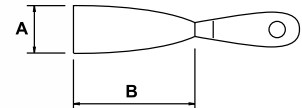

KIT 64 PCS.

| COD | L mm | PCS. |
|-------|------|------|
| 67029 | 30 | 8 |
| | 40 | |
| | 50 | |
| | 60 | |
| | 70 | |
| | 80 | |
| | 90 | |
| | 100 | |



PALANCA BOCA CURVA / PRY BAR / PINCE À TALON COURBE / BRECHSTANGE, GESCHLOSSER / LEVA UNGHIA CHIUSA / ALAVANCA BOCA CURVA / КРИУК

| COD | size | L mm | Kg. | |
|-------|------|------|-----|---|
| 67202 | 6" | 150 | 0,1 | 6 |
| 67203 | 12" | 300 | 0,2 | |
| 67204 | 16" | 405 | 0,5 | |
| 67205 | 20" | 490 | 0,8 | |



| COD | Composición / Composition | Kg. | |
|-------|----------------------------|-----|---|
| 67206 | 67202, 67203, 67204, 67205 | 1.6 | 1 |

PALANCA DE ENCOFRADOR / WRECKING BAR / PINCE À DECOFFRER / NAGELEISEN / LEVERINO CARPENTIERE / ALAVANCAS DE ENCOFRADOR / МОТИРОВА

| COD | L | mm | gr. |
|-------|-----|----|------|
| 63261 | 12" | 14 | 250 |
| 63262 | 18" | 16 | 700 |
| 63263 | 24" | | 1400 |
| 63264 | 30" | 18 | 2000 |
| 63265 | 36" | | 2400 |
| 63266 | 42" | 19 | 2750 |
| 63267 | 48" | | 3100 |



25 CONSTRUCCIÓN / CONSTRUCTION / CONSTRUCTION / BAUWESEN / COSTRUZIONI / CONSTRUÇÃO / СТРОИТЕЛЬСТВО

PERFORADORAS / DRILLS / CAROTTEUSE À BETON / BOHRGERÄTE / PERFORATORE /
PERFURADORAS / КОРОНКИ

PERFORMATIC - 80

| COD | CAP. Ø | W | V | * R | R.P.M. | Kg. |
|-------|--------|------|--------------------|------------|----------|-----|
| 60226 | 12-80 | 1500 | 220-240V (50-60Hz) | 1/2" BSP | 950-2100 | 7,5 |
| 60227 | | | 110-130V (50-60Hz) | 1.1/4" UNC | | |

* 1/2": Hembra / Female / Femelle - 1.1/4": Macho / Male / Male

SSR: Sistema de arranque suave / Soft start system / Système doux de démarrage



CE*G12

PERFORMATIC - 102

| COD | CAP. Ø | W | V | * R | R.P.M. | Kg. |
|-------|--------|------|--------------------|------------|----------|-----|
| 60228 | 12-102 | 1500 | 220-240V (50-60Hz) | 1/2" BSP | 950-2100 | 22 |
| 60229 | | | 110-130V (50-60Hz) | 1.1/4" UNC | | |

* 1/2": Hembra / Female / Femelle - 1.1/4": Macho / Male / Male

SSR: Sistema de arranque suave / Soft start system / Système doux de démarrage

PRCD: Incluido / Included / Inclue

(Para evitar picos de tensión / To avoid voltage picks / Pour éviter des pics de tension)



CE*G12

PERFORMATIC - 205

| COD | CAP. Ø | W | V | * R | R.P.M. | L | 90° | Ventosa | Kg. |
|-------|--------|------|---------------------|------------------------|--------|---|-----|---------|-----|
| 60230 | 12-205 | 2400 | 220-240V 50-60Hz | 1/2" BSP 1.1/4" UNC | 600 | ● | ● | ● | 41 |
| 60231 | | | | | | ● | ● | | |
| 60232 | | | | | | ● | ● | | |
| 60233 | | | ● | | | ● | | | |
| 60234 | | | ● | | | ● | | | |
| 60235 | | | ● | | | ● | | | |
| 60236 | | | ● | | | ● | | | |
| 60237 | ● | ● | | | | | | | |

* 1/2": Hembra / Female / Femelle - 1.1/4": Macho / Male / Male

PRCD: Incluido / Included / Inclue

(Para evitar picos de tensión / To avoid voltage picks / Pour éviter des pics de tension)

Soporte fijo / Fixed bracket / Support fixe

Soporte reclinable 90° / 90° reclining bracket / Support inclinable 90°

Ventosa / Vacuum base / Ventouse



CE*G12

PERFORMATIC - 255

| COD | CAP. Ø | W | V | * R | R.P.M. | L | 90° | Ventosa | Kg. |
|-------|--------|------|---------------------|------------------------|---------|---|-----|---------|-----|
| 60239 | 12-255 | 2600 | 220-240V 50-60Hz | 1/2" BSP 1.1/4" UNC | 460-900 | ● | ● | ● | 45 |
| 60240 | | | | | | ● | ● | | |
| 60241 | | | | | | ● | ● | | |
| 60242 | | | ● | | | ● | | | |
| 60243 | | | ● | | | ● | | | |
| 60244 | | | ● | | | ● | | | |
| 60245 | | | ● | | | ● | | | |

PERFORMATIC - 300

| COD | CAP. Ø | W | V | * R | R.P.M. | L | 90° | Ventosa | Kg. |
|-------|--------|------|---------------------|------------------------|---------|---|-----|---------|-----|
| 60246 | 12-300 | 3300 | 220-240V 50-60Hz | 1/2" BSP 1.1/4" UNC | 460-900 | ● | ● | ● | 50 |
| 60247 | | | | | | ● | ● | | |
| 60248 | | | | | | ● | ● | | |
| 60249 | | | ● | | | ● | | | |
| 60250 | | | ● | | | ● | | | |
| 60251 | | | ● | | | ● | | | |
| 60252 | | | ● | | | ● | | | |
| 60253 | ● | ● | | | | | | | |

* 1/2": Hembra / Female / Femelle - 1.1/4": Macho / Male / Male

PRCD: Incluido / Included / Inclue

(Para evitar picos de tensión / To avoid voltage picks / Pour éviter des pics de tension)



CE*G12

*G12: GARANTIA 12 MESES / 12 MONTHS OF WARRANTY / 12 MOIS DE GARANTIE / 12 MONATEN GARANTIE / 12 MAANDEN GARANTIE / 12 MESI DI GARANZIA / 12 МЕСЯЦЕВ ГАРАНТИЯ

BROCA DE HORMIGÓN, SEGMENTOS DE DIAMANTE SINTERIZADOS / SINTERED DIAMOND DRILLS FOR REINFORCED CONCRETE DRILLS / COURONNES AVEC INTEGRATION DES SEGMENTS DIAMANTES POUR LE FORAGE DE BETONS ARMES / DIAMANT-BOHRKRONEN FÜR STAHL UND BETON / CORONA PER CEMENTO ARMATO, PUNTA DIAMANTATA SINTERIZZATA / BROCA PARA CIMENTO ARMADO, SEGMENTOS DE DIAMANTE SINTERIZADOS / АЛМАЗНЫЕ КОРОНКИ ДЛЯ СВЕРЛЕНИЯ ЖЕЛЕЗОБЕТОНА

PARA CORTE HÚMEDO / FOR WET CUT / FORAGE À L'EAU / ZUM NASSBOHREN / PER TAGLIO AD ACQUA / PARA CORTE HUMIDO / ДЛЯ МОКРОГО СВЕРЛЕНИЯ

| COD A | Ø x L | R |
|-------|---------|------------------------------------|
| 64366 | 32x360 | 1.1/4" UNC HEMBRA FEMALE |
| 64367 | 44x360 | |
| 64368 | 53x360 | |
| 64369 | 63x360 | |
| 64370 | 71x360 | |
| 64371 | 83x360 | |
| 64372 | 89x360 | |
| 64373 | 102x360 | |
| 64374 | 110x360 | |
| 64375 | 120x360 | |
| 64376 | 127x360 | |
| 64377 | 132x360 | |
| 64378 | 150x360 | |
| 64379 | 159x360 | |
| 64380 | 166x360 | |
| 64381 | 180x360 | |
| 64382 | 202x360 | |
| 64383 | 220x360 | |
| 64384 | 244x360 | |
| 64385 | 300x360 | |
| 57100 | 32x450 | |
| 57101 | 44x450 | |
| 57102 | 53x450 | |
| 57103 | 63x450 | |
| 57104 | 71x450 | |
| 57105 | 83x450 | |
| 57106 | 89x450 | |
| 57107 | 102x450 | |
| 57108 | 110x450 | |
| 57109 | 120x450 | |
| 57110 | 127x450 | |
| 57111 | 132x450 | |
| 57112 | 150x450 | |
| 57113 | 159x450 | |
| 57114 | 166x450 | |
| 57115 | 180x450 | |
| 57116 | 202x450 | |
| 57117 | 220x450 | |
| 57118 | 244x450 | |
| 57119 | 300x450 | |



PARA CORTE HÚMEDO / FOR WET CUT / FORAGE À L'EAU / ZUM NASSBOHREN / PER TAGLIO AD ACQUA / PARA CORTE HUMIDO / ДЛЯ МОКРОГО СВЕРЛЕНИЯ

| COD B | Ø x L | R |
|-------|---------|-------------------------------|
| 64355 | 12x120 | 1/2" BSP MACHO MALE |
| 64356 | 18x220 | |
| 64357 | 26x320 | |
| 64358 | 32x320 | |
| 64359 | 44x320 | |
| 64360 | 53x320 | |
| 64361 | 63x320 | |
| 64362 | 71x320 | |
| 64363 | 83x320 | |
| 64364 | 89x320 | |
| 64365 | 102x320 | |



PARA CORTE SECO / FOR DRY CUT / FORAGE À SEC / ZUM TROCKENBOHREN / PER TAGLIO ASCIUTO / PARA CORTE SECO / ДЛЯ СУХОГО СВЕРЛЕНИЯ

| COD | Ø x L | R |
|-------|---------|-------------------------------|
| 64386 | 32x300 | 1/2" BSP MACHO MALE |
| 64387 | 44x300 | |
| 64388 | 53x300 | |
| 64389 | 63x300 | |
| 64390 | 71x300 | |
| 64391 | 83x300 | |
| 64392 | 89x300 | |
| 64393 | 102x300 | |
| 64394 | 110x300 | |
| 64395 | 120x300 | |
| 64396 | 132x300 | |
| 64397 | 150x300 | |



25 CONSTRUCCIÓN / CONSTRUCTION / CONSTRUCTION / BAUWESEN / COSTRUZIONI / CONSTRUÇÃO / СТРОИТЕЛЬСТВО

SOPORTE FIJO / FIXED BRACKET / SUPPORT FIXE / STÄNDER / SUPPORTO FISSO / SUPORTE FIXO / СТАНИНА ДЛЯ СВЕРЛЕНИЯ

| COD | | Kg. |
|-------|----------------|-----|
| 64398 | PERFOMATIC-205 | 22 |
| | PERFOMATIC-255 | |
| | PERFOMATIC-300 | |



SOPORTE RECLINABLE 90° / 90° RECLINABLE BRACKET / SUPPORT INCLINABLE 90° / STÄNDER 90° SCHWENKBAR / SUPPORTO INCLINABILE 90° / SUPORTE INCLINAVEL 90° / СТАНИНА ДЛЯ СВЕРЛЕНИЯ ПОД УГЛОМ

| COD | | Kg. |
|-------|----------------|-----|
| 64399 | PERFOMATIC-205 | 35 |
| | PERFOMATIC-255 | |
| | PERFOMATIC-300 | |



VENTOSA / VACUUM BASE / VENTOUSE / VAKUUMPLATTE / VENTOSA / VENTOSA / ВАКУУМНАЯ ПЛИТА

| COD | | | | Kg. |
|-------|----------------|-------|-------|-----|
| 64400 | PERFOMATIC-205 | 64409 | 64410 | 6,5 |
| | PERFOMATIC-255 | | | |
| | PERFOMATIC-300 | | | |



EXTENSIÓN / EXTENSION / EXTENSION / VERLÄNGERUNG / ESTENSORE / EXTENÇÃO / УДЛИНИТЕЛЬ

| COD | A-B | Ø x L | Kg. |
|-------|------------|--------|-----|
| 64406 | 1.1/4" UNC | 40x150 | 1,0 |
| 64407 | | 40x210 | 1,3 |
| 64414 | 1/2" BSP | 30x200 | 0,8 |
| 64415 | | 30x260 | 1,1 |



MANGO / HANDLE / MANCHE / GRIFF / MANICO / PUNHO / РУКОЯТКА

| COD | | Kg. |
|-------|----------------|-----|
| 64408 | PERFOMATIC-80 | 0,7 |
| | PERFOMATIC-102 | |



CONECTOR ADAPTADOR ROSCA / THREAD CONNECTION ADAPTOR / CONNECTEUR ADAPTATEUR DE FILETAGE / ADAPTOR VERBINDUNGSADAPTER FÜR GEWINDE / ADATTATORE CONNETTORE FILETTATO / ADAPTADOR DE ROSCA / РЕЗЬБОВОЙ ПЕРЕХОДНИК



| COD | A-B | Kg. |
|-------|-------------------------|-----|
| 64426 | * 1.1/4" UNC - 1/2" BSP | 0,4 |



* Hembra / Female / Femelle - Hembra / Female / Femelle

MÁQUINAS DE CORTE / CUTTING MACHINES / MACHINES DE COUPE / SCHNEIDMASCHINEN /
MACCHINE DA TAGLIO / MACCHINA TAGLIATRICE / МАШИНЫ ДЛЯ РУБКИ АРМАТУРЫCORTAVARILLAS ELECTROHIDRÁULICO / ELECTROHYDRAULIC REBAR CUTTERS / COUPE BOULON ELECTRO-
HYDRAULIQUE / ELEKTRO-HYDRAULISCHER STAHLDRANTSCHNEIDER / TAGLIABULLONI ELETTRICO /
TESOURA CORTA VARÃO ELECTRO HIDRAULICA / ЭЛЕКТРОГИДРАВЛИЧЕСКИЕ РУБИКИ АРМАТУРЫ

REBARMATIC - 16 PORTABLE

| COD | V | CAP | W |  |  |
|-------|---------------------|----------|-----|---|---|
| 60274 | 110-240V 50-60Hz | Ø4-Ø16mm | 690 | 64692 | 5,6 |



Especificaciones técnicas / Technical specification / Détails techniques

| | |
|--|------------------|
| Capacidad / Capacity / Capacité | 4mm-16mm |
| Velocidad de corte / Cutting speed / Vitesse de coupe | 3 sg (16mm) |
| Cabezal giratorio / Revolving head / Tête pivotante | 360° |
| Batería / Battery / Piles | Ni-Mh DC 18V 3Ah |
| Baterías incluidas / Included batteries / Piles incluses | 2 pcs |
| Sistema electrohídrico / Electrohydraulic system Système electrohydraulique | ● |
| Tamaño estuche / Case dimensions / Dimension de l'étui | 415x390x135mm |
| Estuche metálico / Metallic case / Etui métallique | ● |
| Juego cuchillas / Blade set / Jeu de couteaux | 64692 |



CE*G12

REBARMATIC - 16

| COD | V | CAP | W |  |  |
|-------|--------------------|----------|-----|--|--|
| 60270 | 220-240V (50-60Hz) | Ø4-Ø16mm | 690 | 64177 | 8 |
| 60272 | 110V (50-60Hz) | | | | |



Especificaciones técnicas / Technical specification / Détails techniques

| | |
|--|---------------|
| Capacidad / Capacity / Capacité | 4mm-16mm |
| Velocidad de corte / Cutting speed / Vitesse de coupe | 3 sg (16mm) |
| Sistema electrohídrico / Electrohydraulic system Système electrohydraulique | ● |
| Tamaño estuche / Case dimensions / Dimension de l'étui | 460x150x115mm |
| Estuche metálico / Metallic case / Etui métallique | ● |
| Juego cuchillas / Blade set / Jeu de couteaux | 64177 |



CE*G12

REBARMATIC - 22

| COD | V | CAP | W |  |  |
|-------|--------------------|----------|-----|---|---|
| 60271 | 220-240V (50-60Hz) | Ø4-Ø22mm | 850 | 64178 | 12 |
| 60273 | 110-130V (50-60Hz) | | | | |

Especificaciones técnicas / Technical specification / Détails techniques

| | |
|--|---------------|
| Capacidad / Capacity / Capacité | 4mm-22mm |
| Velocidad de corte / Cutting speed / Vitesse de coupe | 3 sg (22mm) |
| Sistema electrohídrico / Electrohydraulic system Système electrohydraulique | ● |
| Tamaño estuche / Case dimensions / Dimension de l'étui | 420x130x150mm |
| Estuche metálico / Metallic case / Etui métallique | ● |
| Juego cuchillas / Blade set / Jeu de couteaux | 64178 |



CE*G12

ÁNTES / BEFORE / AVANT



DESPUÉS / AFTER / APRÈS



25 CONSTRUCCIÓN / CONSTRUCTION / CONSTRUCTION / BAUWESEN / COSTRUZIONI / CONSTRUÇÃO / СТРОИТЕЛЬСТВО

TRONZADORA DISCO ABRASIVO / CUT-OFF MACHINE / MEULEUSE À DISQUES ABRASIFS / TRENNSCHLEIFMASCHINE / MACCHINA DA TAGLIO / CORTADORA DE DISCO ABRASIVO / АБРАЗИВНАЯ ПИЛА

| COD | Ø | V | W | R.P.M. | Kg. |  |
|-------|-----|--------------------|------|--------|-----|--|
| 60254 | 355 | 220-240V (50-60Hz) | 2300 | 3900 | 19 | 83182 |
| 60255 | | 110-130V (50-60Hz) | | | | |



CE*G12

SIERRA PARA LADRILLOS CON MESA / BENCH BRICKS CUT-OFF MACHINE / SCIE À BRIQUES AVEC TABLE / TISCHKREISSÄGE FÜR BACKSTEIN / MACCHINA DA TAGLIO CON BANCO / SERRA PARA CORTAR MOSAICOS CON MESA / НАСТОЛЬНАЯ ПИЛА ДЛЯ КИРПИЧА

| COD | Ø | CAP | V | W | R.P.M. | Kg. |
|-------|-----|-------------|--------------------|------|--------|-----|
| 60256 | 355 | 255x406x127 | 220-240V (50-60Hz) | 1650 | 3500 | 21 |
| 60257 | | | 110-130V (50-60Hz) | | | |



CE*G12

REFRIGERADA POR AGUA / WATER-COOLED / REFRROIDISEUR D'EAU / WASSERKÜHLED
ACQUA REFFRIGERATA / WATERGEKOELD / DE REFRIGERAÇÃO POR AGUA /
С ВОДЯНЫМ ОХЛАЖДЕНИЕМ

SIERRA PARA LADRILLOS / BRICKS CUT-OFF SAW / SCIE À BRIQUES / KREISSÄGE FÜR BACKSTEIN / MACCHINA DA TAGLIO / SERRA PARA CORTAR MOSAICOS / ПИЛА ДЛЯ ОТРЕЗКИ КИРПИЧЕЙ

| COD | Ø | CAP | V | W | R.P.M. | Kg. |
|-------|-----|-------------|--------------------|------|--------|-----|
| 60258 | 355 | 255x406x127 | 220-240V (50-60Hz) | 1650 | 3500 | 11 |
| 60259 | | | 110-130V (50-60Hz) | | | |



CE*G12

REFRIGERADA POR AGUA / WATER-COOLED / REFRROIDISEUR D'EAU / WASSERKÜHLED
ACQUA REFFRIGERATA / WATERGEKOELD / DE REFRIGERAÇÃO POR AGUA /
С ВОДЯНЫМ ОХЛАЖДЕНИЕМ

*G12: GARANTIA 12 MESES / 12 MONTHS OF WARRANTY / 12 MOIS DE GARANTIE / 12 MONATEN GARANTIE / 12 MAANDEN GARANTIE / 12 MESI DI GARANZIA / 12 МЕСЯЦЕВ ГАРАНТИЯ