

PRESENTACIÓN

Los cilindros anticorrosión están adaptados para una utilización en medios agresivos:

- ambientes químicos, salinos o húmedos
- entorno alimentario, lecherías, queserías e industrias cárnicas: gran resistencia al ácido láctico y a los regados con aditivos antibacterianos

INFORMACIÓN GENERAL

Detección	Previstos para detectores magnéticos de posición
Presión de utilización	10 bar, máx. [1 bar =100 kPa]
Temperatura ambiente	-20°C a +80°C
Normas	ISO 6431

fluidos (*)	rango de temperatura (TS)
aire o gas neutro filtrado a 50 µm, lubricado o no	-20°C a +80°C

MATERIALES EN CONTACTO CON EL FLUIDO

(*) Verifique la compatibilidad del fluido con los materiales en contacto

Tubo amagnético	Acero inoxidable, AISI 304
Vástago	Acero inoxidable, AISI 303, AISI 316 L
Junta de vástago	FPM (elastómero fluorado)
Fondos delantero y trasero	Acero inoxidable, AISI 304
Casquillo	Aleación ligera - POM Acetal
Junta de pistón	PUR (poliuretano)
Junta rascador	FPM (elastómero fluorado), PTFE en opción
CONSTRUCCIÓN	
Amortiguación	Neumática regulable
Desmontaje	Cilindro desmontable
Tuerca de vástago	Acero inoxidable, AISI 316 L
Casquillo metálico	Material composite



B

COMO REALIZAR UN PEDIDO

CODIGO 15-DIGITOS

G 431 A 5 3 K 0080 A00

Conexión roscada
G = ISO 16030

Serie producto
431

Letra de revisión
A = Versión inicial

Diámetro (mm)
3 = 32
4 = 40
5 = 50
6 = 63
8 = 80

Opciones de vástago
3 = Simple vástago, Acero
4 = Vástago pasante, Acero
6 = Simple vástago, AISI 316 L
7 = Vástago pasante, AISI 316 L

Junta de vástago y junta rascador
K = Junta de vástago de FPM (Standard)
P = Junta de vástago de FPM + Junta rascador de PTFE
C = Junta de vástago de FPM + Junta rascador de PTFE de cartucho

Opciones

- A00** = Simple vástago, Fondo trasero y fondo delantero lisos
- PRC** = Simple vástago, Fondo delantero roscado, Fondo trasero liso
- TRE** = Simple vástago, Fondo delantero standard, Tenón trasero integrado
- THR** = Vástago pasante (Fondos roscados)

Carreras standard recomendadas (mm) ⁽¹⁾

Ø mm	Ø racord-daje (G)	25	50	80	100	125	160	200	250	320	400	500	Carrera min	Carrera máx.
32	G1/8	●	●	●	●	●	●	●	●				20	1000
40	G1/4	●	●	●	●	●	●	●	●	●	●		20	1000
50	G1/4	●	●	●	●	●	●	●	●	●	●	●	30	1000
63	G3/8	●	●	●	●	●	●	●	●	●	●	●	30	1000
80	G3/8	●	●	●	●	●	●	●	●	●	●	●	30	1000

(1) Otras carreras (consultar)

DETECTORES DE POSICIÓN

Detectores magnéticos de posición IP69K y collar de acero inox., ver página P291

INSTALACIÓN

- Posibilidad de montaje de los cilindros en cualquier posición
- Fijaciones de acero inox.: **código**

Ø (mm)	horquilla hembra de extremo de vástago ISO 8140 AP2	tenón con rótula de extremo de vástago ISO 8139 AP6	tuerca de fondo MR3	escuadras de extremo MS1	tenón trasero desmontable MP4	tenón trasero recto con rótula MP6	horquilla trasera para tenón con rótula
32	43400566	43400570	43400574	43400578	43400584	43400590	43400596
40	43400567	43400571	43400575	43400579	43400585	43400591	43400597
50	43400568	43400572	43400576	43400580	43400586	43400592	43400598
63	43400568	43400572	43400576	43400581	43400587	43400593	43400599
80	43400569	43400573	43400577	43400582	43400588	43400594	43400600

- Los orificios de recordaje 1/4-3/8-1/2 (G*) son conforme a las normas ISO 228/1 e ISO 7/1. El orificio G 1/8 es conforme a la norma ISO 228/1
- Las instrucciones de instalación/mantenimiento están incluidas con cada cilindro

DIMENSIONES (mm)



CILINDRO DE SIMPLE VÁSTAGO

Fondo trasero y fondo delantero lisos (opción: A00)
 Para fijación trasera desmontable
 Suministrado sin tuerca de fondo delantera
 ISO 6431

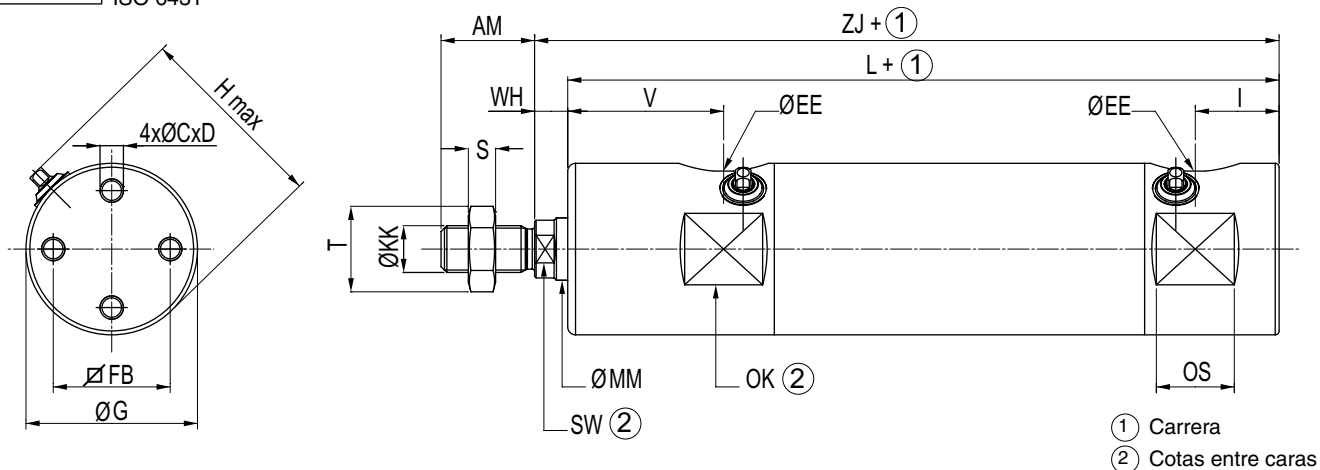

Ø (mm)	AM	C	D	ØEE	FB	G	H MAX	I	ØKK	L	MM	OK	OS	S	SW	T	V	WH	ZJ
32	22	M5	7	G1/8	25	36	44,70	17,5	M10x1,25	115,5	12	33	16,5	5	10	17	34	8	123,5
40	24	M6	8	G1/4	30	44	52,45	21,5	M12x1,25	135,5	16	40	20	6	13	19	40	8,5	141
50	32	M6	8	G1/4	39	54	62,45	19	M16x1,5	135	20	50	19	8	17	24	44,5	13	148
63	32	M8	8	G3/8	49	68	76,45	22,5	M16x1,5	151	20	64	24	8	17	24	44	13	164
80	40	M10	8,5	G3/8	64	86	94,60	25,5	M20x1,5	164	25	82	24	10	21	30	51	15,5	179,5

DIMENSIONES (mm)



CILINDRO DE SIMPLE VÁSTAGO

Fondo delantero roscado, Fondo trasero liso (opción: PRC)
 Para fijación trasera desmontable
 Suministrado sin tuerca de fondo delantera
 ISO 6431

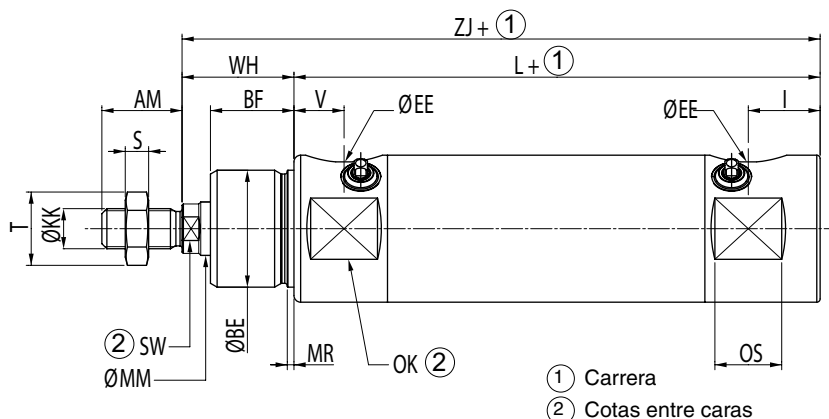
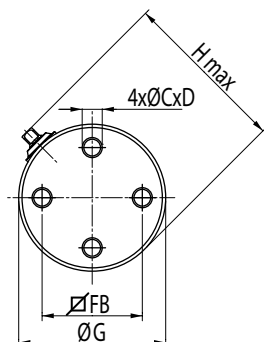

Ø (mm)	AM	BE	BF	C	D	ØEE	FB	G	H MAX	I	ØKK	L	MM	MR	OK	OS	S	SW	T	V	WH	ZJ
32	22	M30x1,5	22	M5	7	G1/8	25	36	44,70	17,5	M10x1,25	92,5	12	2	33	16,5	5	10	17	12	31	123,5
40	24	M35x1,5	25	M6	8	G1/4	30	44	52,45	21,5	M12x1,25	106,5	16	2	40	20	6	13	19	15	34,5	141
50	32	M42x1,5	28	M6	8	G1/4	39	54	62,45	19	M16x1,5	107	20	2	50	19	8	17	24	16,5	41	148
63	32	M42x1,5	28	M8	8	G3/8	49	68	76,45	22,5	M16x1,5	123	20	2	64	24	8	17	24	16	41	164
80	40	M50x2,0	28	M10	8,5	G3/8	64	86	94,60	25,5	M20x1,5	136	25	2	82	24	10	21	30	23	43,5	179,5



CILINDRO DE SIMPLE VÁSTAGO

Fondo delantero liso, Tenón trasero integrado (opción: TRE)
 Suministrado sin tuerca de fondo delantera
 ISO 6431

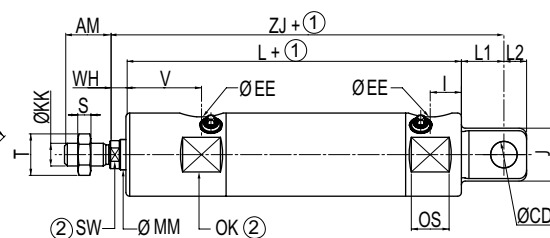
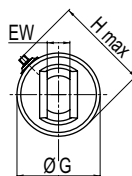

CILINDRO DE VÁSTAGO PASANTE

Fondos roscados (opción: THR)
 ISO 15552-AFNOR - DIN

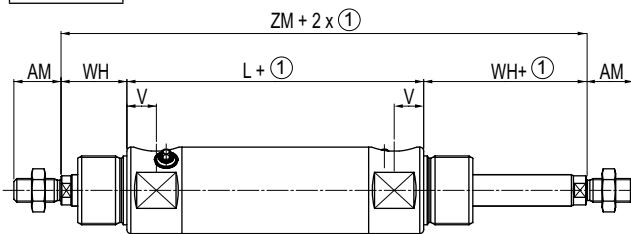

Ø (mm)	AM	ØCD	ØEE	G	H MAX	I	J	ØKK	L	L1	L2 EW	MM	OK	OS	S	SW	T	V	WH	ZJ	Ø (mm)	AM	L	V	WH	ZM
32	22	10	G1/8	36	44,70	12	24	M10x1,25	109	22,5	10	12	33	16,5	5	10	17	34	8	140,5	32	22	88	12	31	150
40	24	12	G1/4	44	52,45	16,5	28	M12x1,25	126,5	22,5	12	16	40	20	6	13	19	40	8,5	158,5	40	24	101	15	34,5	170
50	32	16	G1/4	54	62,45	15,5	30	M16x1,5	131,5	27	16	20	50	19	8	17	24	44,5	13	171,5	50	32	105,5	16,5	41	187,5
63	32	16	G3/8	68	76,45	21,5	40	M16x1,5	150	27	16	20	64	24	8	17	24	44	13	190	63	32	117	16	41	199
80	40	20	G3/8	86	94,60	20	50	M20x1,5	158,5	36	20	25	82	24	10	21	30	51	15,5	210	80	40	134,5	23	43,5	221,5



OPCIONES

Junta rascador de PTFE de cartucho

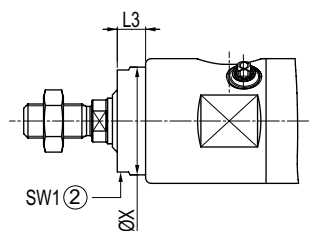
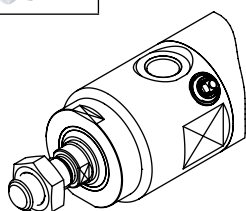

Ø (mm)	ØX	L3	SW1
32	31	5	27
40	38	5	36
50	40	5	36
63	40	5	36
80	53	5	46

01420ES-2012/R03
 Las especificaciones y dimensiones pueden ser modificadas sin previo aviso. Todos los derechos reservados.

DIMENSIONES (mm), PESOS (kg)

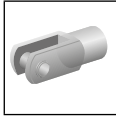

FIJACIÓN

Horquilla hembra para extremo de vástago
ISO 8140
AP2

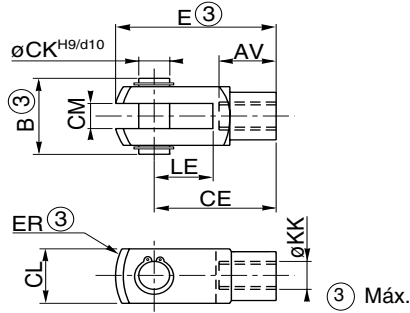

③ Máx.

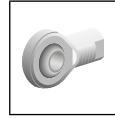

FIJACIÓN

Tenón con rótula de extremo de vástago
ISO 8139
AP6

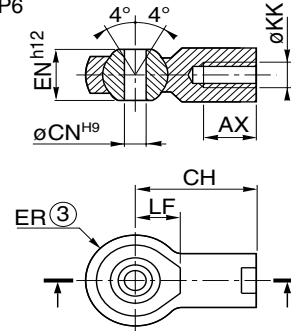

Ø (mm)	AV	B	CE	CK	CL	CM	E	ER	KK	LE	peso
32	20	26	40	10	20	10	52	13	M10x1,25	20	0,09
40	23	31	48	12	24	12	62	15	M12x1,25	24	0,16
50	34	39	64	16	32	16	83	20	M16x1,5	32	0,31
63	34	39	64	16	32	16	83	20	M16x1,5	32	0,31
80	40	48	80	20	40	20	105	25	M20x1,5	40	0,67

Ø (mm)	AX	CH	CN	EN	ER	LF	KK	peso
32	20	43	10	14	13	14	M10x1,25	0,076
40	23	50	12	16	15	16	M12x1,25	0,115
50	34	64	16	21	20	22	M16x1,5	0,230
63	34	64	16	21	20	22	M16x1,5	0,230
80	40	77	20	25	25	26	M20x1,5	0,415



FIJACIÓN

Escuadras de extremo
MS1

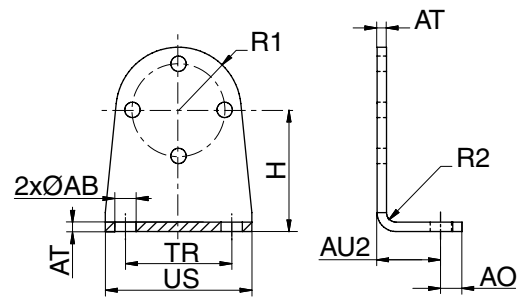
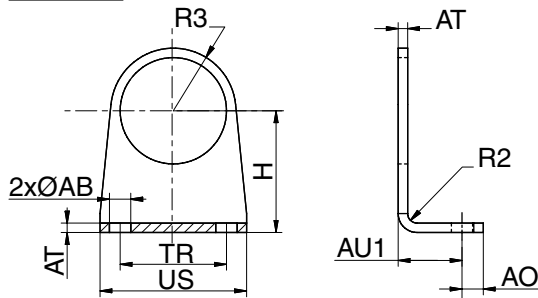

Ø (mm)	AB	AO	AU1	AU2	AT	H	R1	R2	R3	TR	US	peso
32	7	9	28,5	20,5	3	33	17,5	3	17,5	32	45	0,075
40	9	9	32	22	3	38	21,5	3	21,5	36	52	0,090
50	9	9	36	27	4	47	26,5	4	25	45	62	0,170
63	9	9	36	26	4	52	33	4	27	50	72	0,230
80	12	15	38,5	35,5	5	65	42,5	5	31	63	90	0,450

DIMENSIONES (mm), PESOS (kg)

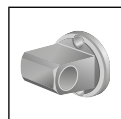

FIJACIÓN

Tenón trasero desmontable
MP4

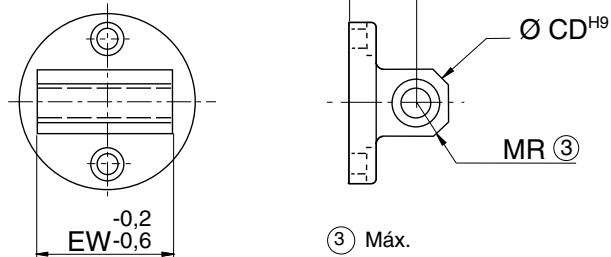

Ø (mm)	CD	EW	MR	L1	peso
32	10	26	11	18,5	0,08
40	12	28	13	19	0,10
50	12	32	13	22	0,17
63	16	40	17	26	0,32
80	16	50	17	30,5	0,58



FIJACIÓN

Tenón trasero desmontable, recto, con rótula
MP6

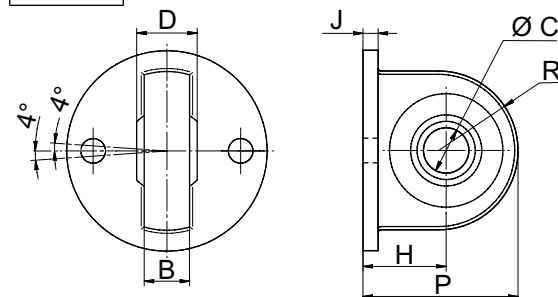

Ø (mm)	B	C	D	H	J	P	R	peso
32	10,5	10	14	18,5	3,5	33,5	15	0,09
40	12	12	16	19	3,5	37	18	0,14
50	12	12	16	22	5	44	22	0,22
63	15	16	21	26	5	48	22	0,34
80	15	16	21	30,5	8	55,5	25	0,60



FIJACIÓN

Horquilla trasera para tenón con rótula

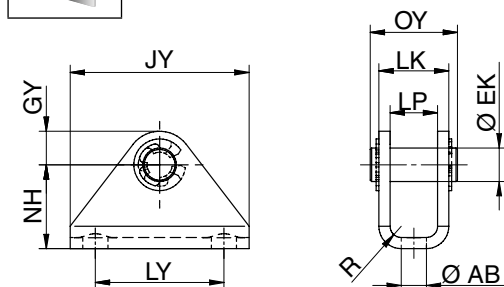

Ø (mm)	AB	EK	GY	JY	LK	LP	LY	NH	OY	R	peso
32	7	10	9	45	21	15	30	24	26	3	0,08
40	9	12	10	55	23	17	38	27	29	3	0,09
50	9	12	10	64	25	17	46	30	31	4	0,18
63	12	16	13	79	30	22	58	36	36	4	0,27
80	14	16	13	94	32	22	70	40	38	5	0,41

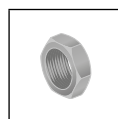

FIJACIÓN

Tuerca de fondo
MR3

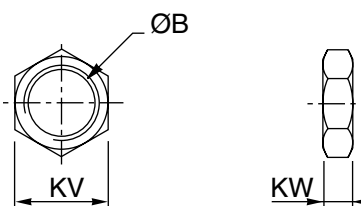

Ø (mm)	ØB	KV	KW	peso
32	M30x1,5	36	10	0,037
40	M35x1,5	41	10	0,043
50	M42x1,5	50	12	0,079
63	M42x1,5	50	12	0,079
80	M50x2	65	12	0,167

01420ES-2012/R01
Las especificaciones y dimensiones pueden ser modificadas sin previo aviso. Todos los derechos reservados.

CÓDIGOS PIEZAS DE RECAMBIO

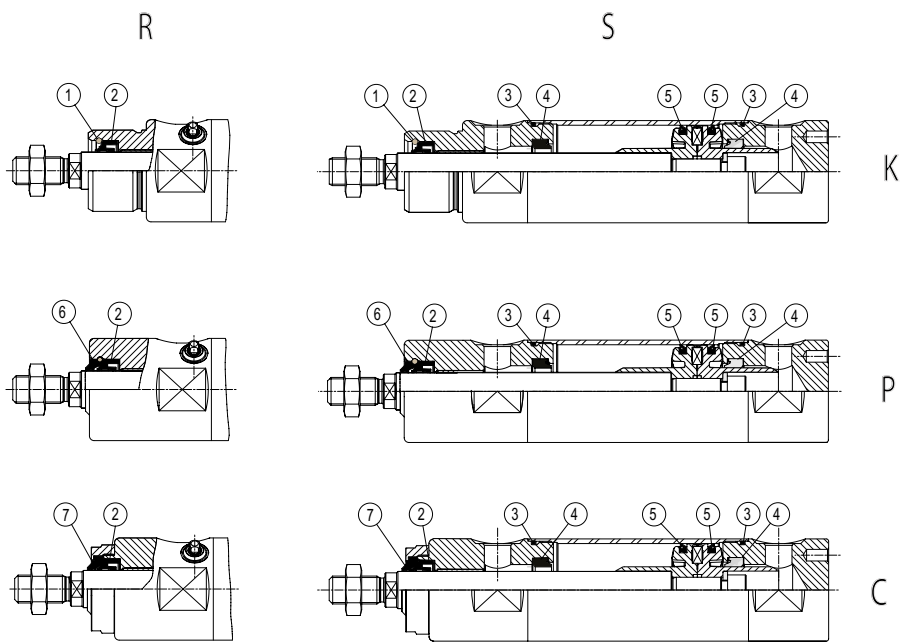

CODIGO 15-DIGITOS

M 431 A 5 S K 0000 A00

Piezas de recambio
M

Serie producto
431

Letra de revisión
A = Versión inicial

Diámetro (mm)

- 3 = 32
- 4 = 40
- 5 = 50
- 6 = 63
- 8 = 80

Junta de vástago y junta rascador

K = Junta de vástago de FPM (Standard)

P = Junta de vástago de FPM + Junta rascador de PTFE

C = Junta de vástago de FPM + Junta rascador de PTFE de cartucho

Tipo de kit

S = Kit completo de juntas

R = Juntas de vástago solamente