

## Modelos

### Módulos / Modules

Módulo para salas de espera/recepciones  
1 ó 2 plazas.

Respaldo medio tapizado y asiento tapizado.

Gomaespuma respaldo densidad 25 asiento 30.

Estructura 4 patas en epoxi negro opción gris  
o estructura en madera , estructura grosor 30 x 2 mm

Brazos opcionales fijos más tapizados , opción  
madera de haya.



Lipy 1 con brazos

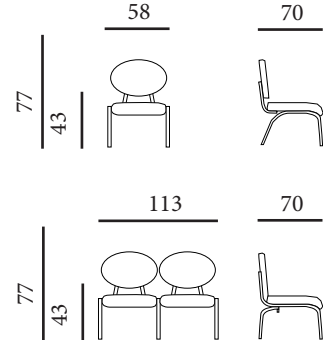

### Mesas / Tables.

Mesa para salas de espera/recepciones

Posibilidad de 57,5 o 97,5 cm de longitud.

Tapa laminada espesor 30 m.m

Estructura en epoxi negro , opcional en epoxi gris  
grosor 30 x 2 mm



Lipy M-G

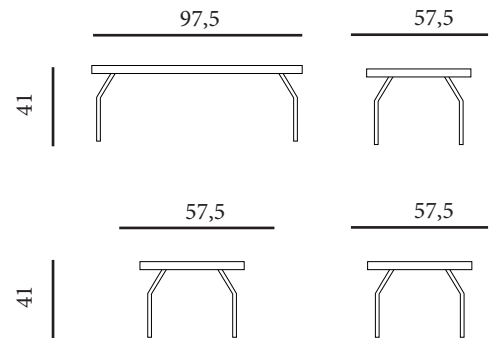

### Estructura / Structure Brazos /

Epoxi gris ral  
9006

Epoxi negro ral 9011

### Detalles / Opciones / Details / Options



Módulo doble / Double module

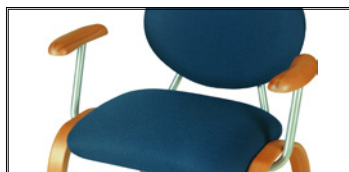





acabado en madera / finition bois







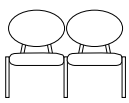

con mesa de ángulo / avec table  
d'angle.

## Precio/Prix

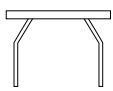
### Módulos / Modules

		Estructura Structure	Basic plus /one	nappel/ xtreme M1	Diabolo M1	Piel vacuna	Tela cliente		
Lipy 1		4 patas epoxi negro o gris	132,26 €	145,50 €	155,66 €	225,73 €	126,98 €	Vol.: 0,30 m <sup>3</sup> Peso: 12,00 Kg Eco taxe 1,15 1 bulto - 1 unidad	
Lipy 1 - M			224,36 €	246,83 €	264,10 €	382,92 €	215,39 €		
Lipy 2		4 patas epoxi negro o gris	265,76 €	291,03 €	311,39 €	451,52 €	255,14 €	Vol.: 0,69 m <sup>3</sup> Peso: 23,50 Kg Eco taxe 2,26 1 bulto - 1 unidad	
Lipy 2 - M			448,78 €	493,65 €	528,21 €	765,92 €	430,83 €		

### Mesa / Table

		TAPA PLATEAU	ESTRUCTURA STRUCTURE				
Lipy M-P		Melamina Melaminé	4 patas epoxi negro o gris	98,05 €		Vol.: 0,15 m <sup>3</sup> Peso: 8,00 Kg Eco taxe 0,77 1 bulto - 1 unidad	
Lipy M-G		Melamina Melaminé	4 patas epoxi negro o gris	120,06 €		Vol.: 0,26 m <sup>3</sup> Peso: 12,56 Kg Eco taxe 1,21 1 bulto - 1 unidad	
Lipy M-ANG		Melamina Melaminé	4 patas epoxi negro o gris	88,82 €		Vol.: 0,04 m <sup>3</sup> Peso: 6,00 Kg Eco taxe 0,58 1 bulto - 1 unidad	

### Brazos / Accoudoirs

	APOYO	Basic plus /one	nappel/ xtreme M1	Diabolo M1	Piel vacuna	Tela cliente
Lipy brazo drcho T Lipy accoudoirs droite	Tapizado Tapissée	16,58 €	18,24 €	19,45 €	28,30 €	15,92 €
Lipy brazo izqdo T Lipy accoudoirs gauche	Tapizado Tapissée					
Lipy brazo drcho T Lipy accoudoirs droite	Madera Bois	37,57 €				
Lipy brazo izqdo T Lipy accoudoirs gauche	Madera Bois					

## mallá

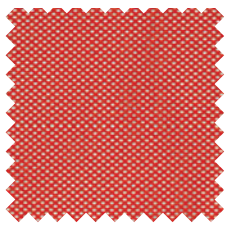

rojo

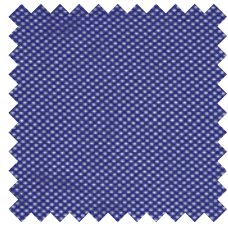

azul

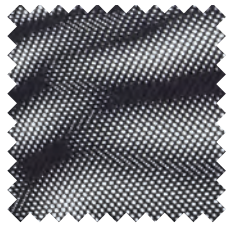

negro

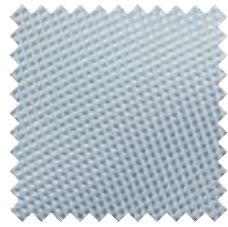

gris

## bonday grupo 1

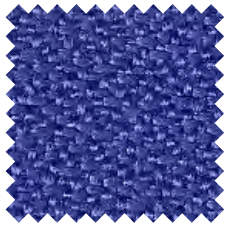

169 azul



1005 beige

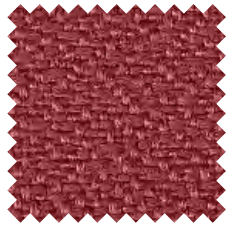

5505 granate

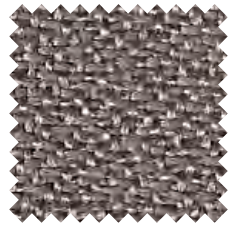

81 gris claro

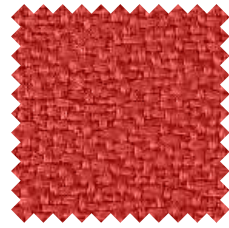

76 naranja



9 negro



5518 gris grafito

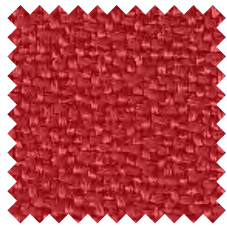

79 rojo



103 verde azulado



77 verde oliva

## point grupo 1

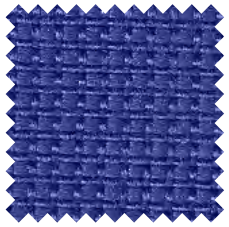

169 azul

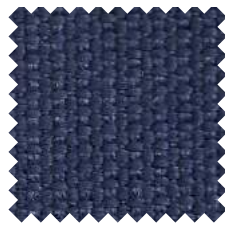

200 azul marino



515 point verde



760 morado

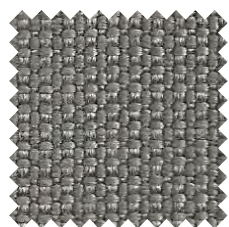

620 gris claro



9 negro



420 marrón



79 rojo

## nappel flor grupo 2



Blanco 00



Verde 42

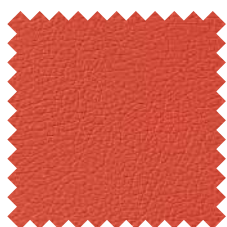

Naranja 35



Rojo 29



azul 69



Morado 28



Chocolate 20



Gris 71



Negro 09

# tapizados

## xtreme plus M1 grupo2



35 azul



91 marron



292 morado

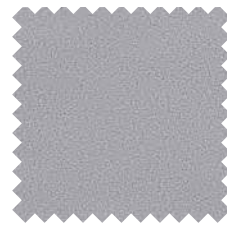

94 gris claro

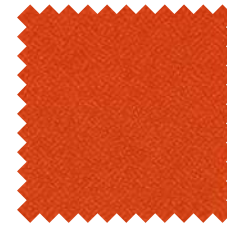

168 naranja



9 negro



79 rojo



156 verde claro



151 verde oliva



72 amarillo

## diabolo M1 grupo3



azul



naranja



negro

## piel grupo 4



negro

blanco



rojo



azul



gris



marrón

## grupo 4 denim plus



rojo



azul

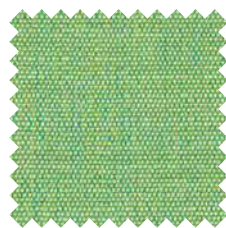

verde

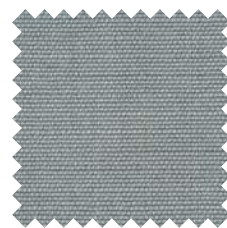

gris medio

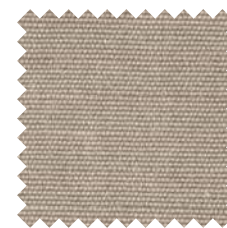

arena

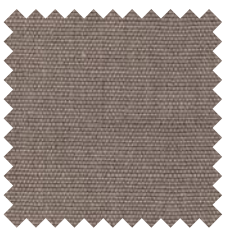

marrón

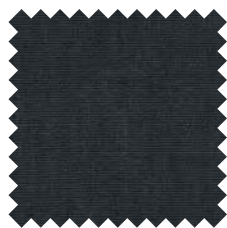

negro

# características técnicas

## Bonday

**Composición** : 100 % Polyolefin.100 % reciclable



**Ancho** : 140 cm.

**Peso** : 300 g. MI + - 5 %.

**Resistencia a la abrasión** + 40.000 ciclos UNE EN ISO 12947 - 2 : 1999.

**Pilling** : 4/5 UNE EN ISO 105-B02:2001.

**Solidez a la luz** : 6 UNE EN ISO 105- B02:2001 ( MÉTODO 2 )

**Solidez al frote** : - En seco 4 / 5 UNE EN ISO 105 - X 12 :2003

- En húmedo 4/ 5 UNE EN ISO 105 - X 12: 2003

**Mantenimiento** : Limpiar en seco.

**Inflamabilidad** : UNE EN 1021 - 1 : 2006 ( cigarrillo)

Condiciones ignífugas dependientes del tipo de foam y cola utilizados.

## Point

**Composición** : 100 % Polyolefin.100 % reciclable



**Ancho** : 140 cm.

**Peso** : 300 g. MI + - 5 %.

**Resistencia a la abrasión** + 40.000 ciclos UNE EN ISO 12947 - 2 : 1999.

**Pilling** : 4/5 UNE EN ISO 105-B02:2001.

**Solidez a la luz** : 6 UNE EN ISO 105- B02:2001 ( MÉTODO 2 )

**Solidez al frote** : - En seco 4 / 5 UNE EN ISO 105 - X 12 :2003

- En húmedo 4/ 5 UNE EN ISO 105 - X 12: 2003

**Mantenimiento** : Limpiar en seco.

**Inflamabilidad** : UNE EN 1021 - 1 : 2006 ( cigarrillo)

Condiciones ignífugas dependientes del tipo de foam y cola utilizados.

## Diabolo M 1

**Composición** : Pvc 84 % - Cotton 16 % .

**Ancho** : 138 - 140 cm.

**Peso** : 750 g. + - 40 g / m2.

**Espesor** : 1,1 mm +/- 0,05 mm

**Ignifugación** : M1 ( NFP 92503 ) AM 18. BS 5852 crib 5.

B 2 ( DIN 4102 ) EN 1021,1-2. IMO A652.

**Abrasión** . Abrasión Martindale 50.000 cycles.

**Solidez del color a la luz**. Mayor o igual a 6.

Ausencia de disolventes.

Eficacia contra las bacterias.( MRSA )

**Mantenimiento eficaz**. Limpiar regularmente con paño húmedo con jabón neutro.

## Denim Plus

**Composición** : 90 % pura lana virgin, 33% FR Viscose.

**Ancho** : 138 - 140 cm.

**Peso** : 330 g/m2 .

**Ignifugación** :EN 1021- 1 : 2006 ( cigarrillo ) EN 1021 2 : 2006 ( cerilla)

**Abrasión** . Abrasión Martindale 40.000 cycles.

**Solidez del color a la luz**. 5 ( ISO 105 - X 12: 2002 ).

**Mantenimiento eficaz**. Limpiar con aspiradora con regularidad. Limpiar en seco , o bien lavar en paño húmedo.

## Nappel

**Composición** : 100 % PU 33 % Cotton , 67 % Polyester.

**Ancho** : 140 cm +/- 2%.

**Peso** : 820 g. MI

**Resistencia a la abrasión** + 200.000 ciclos UNE EN ISO 12947 - 2 : 1999.

**Pilling** : 4/5 UNE EN ISO 105-B02:2001.

**Mantenimiento** : Limpiar con paño húmedo.

**Inflamabilidad** : BS 5852 CRIB 5 UNE EN 1021

Condiciones ignífugas dependientes del tipo de foam y cola utilizados.

## Xtreme plus M1

**Composición** : 100 % Poliéster reciclado.100 % FR.

**Ancho** : 140 cm.

**Peso** : 310 g. m2 MI + - 5 %.

**Resistencia a la abrasión** 100.000 martindale ciclos.

**Pilling** : 5 (BS UNE EN ISO 12945-2-2000).

**Solidez a la luz** : 6 ( ISO 105-B02:1999)

**Solidez al rozamiento** : - Húmedo: 4 Seco : 4 (ISO 105-X12:2002)

**Mantenimiento** : Lavable hasta 60 ° C. Limpiar con aspiradora

frecuentemente.Bien lavar con paño húmedo o con un champú apropiado para tapicería.

**Inflamabilidad** : M1 DIN4102-B1 NF-P-92-503 M1 UNE23725-90 1R M1

Condiciones ignífugas dependientes del tipo de foam y cola utilizados.