

amba

Ofifer 
www.ofifer.es | ofifer@ofifer.es



Características técnicas / Caractéristiques techniques



Tapa y faldón / Plateau et voile de fond

Melamina: Tablero bilaminado de 25 mm de espesor, cantos en pvc de 2 mm de espesor.

Mélamine: Plateau épaisseur 25 mm, chant plaque 2 mm.

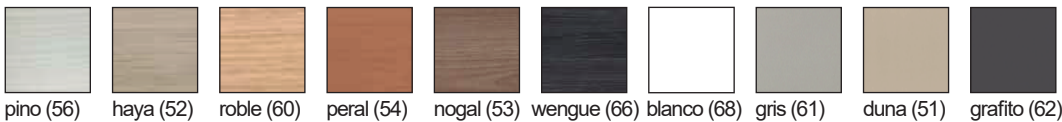

Laterales / Latéraux

Melamina: Tablero bilaminado de 25 mm de espesor, cantos en pvc de 2 mm de espesor.

Mélamine: Latéraux épaisseur 25 mm, chant plaque 2 mm.

Mismo acabado que la tapa, ó:
Même finition que plateau, ou:



Programa / Programme

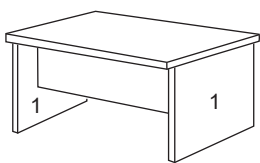

Mesa 800 / Poste droit 800
1-Pata Mesa ancho 800

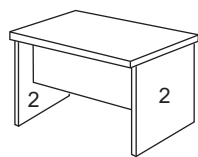

Mesa 600 / Poste droit 600
2-Pata Mesa ancho 600

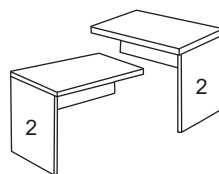

Ala / Retour

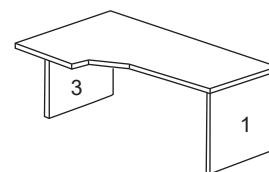

Mesa compacta / Poste compact
3-Pata Mesa ancho 1200

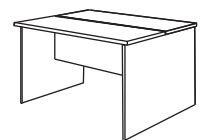

Mesa Bench
Poste Bench

Serie amba

Código de producto / Code:

El código final del pedido vendrá determinado por la referencia del modelo, más el acabado de la tapa y faldón, los laterales, etc.

Le code d'ordre est déterminé par le référence du modèle, ainsi que la finition du plateau et voile de fond, des latéraux, etc.

Ejemplo / Exemple:

Mesa de 1600 x 600, tapa y faldón en pino, laterales en aluminio: **B 218 56 69**

Modelo / Modèle	Tapa, faldón / Plateau, voile	Laterales / Latéraux
B 218	56	69

Poste 1600 x 600, plateau et voile pin, latéraux aluminium: **B 218 56 69**

Melamina tapa y faldón / Mélamine plateau et voile de fond:

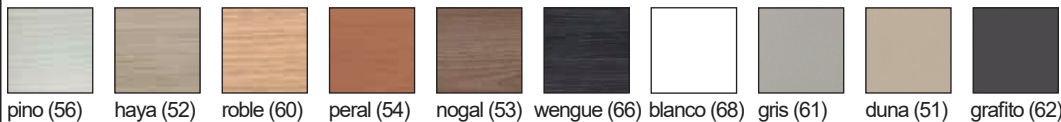

Melamina laterales / Mélamine latéraux:

Mismo acabado que la tapa, ó:

Même finition que plateau, ou:

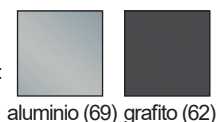

Mesas rectas 800 mm (espesor 25 mm) / Postes droits 800 mm (épaisseur 25 mm)

Cód. / Code	Medidas / Dimensions	P.V.P.	Packing
B 200...		110,64 €	29 kg Vol. 0,15 m ³ Nº bultos: 3
B 202...		127,66 €	34 kg Vol. 0,08 m ³ Nº bultos: 3
B 204...		135,45 €	40 kg Vol. 0,09 m ³ Nº bultos: 3
B 206...		142,80 €	43,50 kg Vol. 0,10 m ³ Nº bultos: 3
B 208...		157,98 €	47 kg Vol. 0,11 m ³ Nº bultos: 3
B 210...		169,04 €	51 kg Vol. 0,12 m ³ Nº bultos: 3



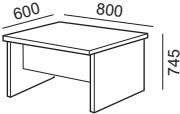
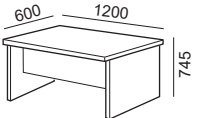
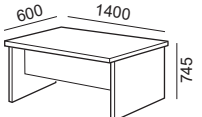
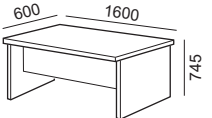

Mesas rectas 600 mm (espesor 25 mm) / Postes droits 600 mm (épaisseur 25 mm)

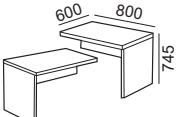
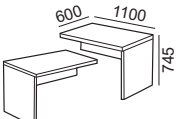
Cód. / Code	Medidas / Dimensions	P.V.P.	Packing
B 212...		96,84 €	23,50 kg Vol. 0,038 m ³ Nº bultos: 4
B 214...		110,10 €	30 kg Vol. 0,047 m ³ Nº bultos: 4
B 216...		117,45 €	32,50 kg Vol. 0,051 m ³ Nº bultos: 4
B 218...		124,88 €	35,50 kg Vol. 0,055 m ³ Nº bultos: 4

Alas (espesor 25 mm) / Retours (épaisseur 25 mm)

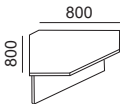
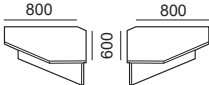
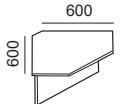
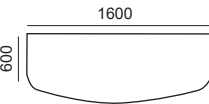
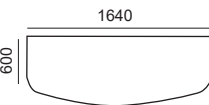
Cód. / Code	Medidas / Dimensions	P.V.P.	Packing
Reversible / Réversible B 230...		77,06 €	21,74 kg Vol. 0,026 m ³ Nº bultos: 3
Reversible / Réversible B 220...		89,33 €	38,96 kg Vol. 0,132 m ³ Nº bultos: 3

Ángulos y terminales luna (espesor 25 mm) / Angles et extension (épaisseur 25 mm)

Cód. / Code	Medidas / Dimensions	P.V.P.	Packing
C 290...		130,85 €	14,91 kg Vol. 0,030 m ³ Nº bultos: 2
Al hacer el pedido indicar mano del ángulo / Indiquer la main d'angle C 292...		125,93 €	12,20 kg Vol. 0,024 m ³ Nº bultos: 2
C 294...		120,11 €	10,18 kg Vol. 0,022 m ³ Nº bultos: 2
C 296...		103,93 €	14,64 kg Vol. 0,024 m ³ Nº bultos: 1
C 297...		104,65 €	14,64 kg Vol. 0,024 m ³ Nº bultos: 1
C 502...	Pata pedestal cuadrada 50x50. Pied 50x50. Ej.: Pata blanca: C 502 91 <div style="display: flex; align-items: center; gap: 10px; margin-top: 5px;"> <div style="text-align: center;">  blanco (91) </div> <div style="text-align: center;">  aluminio (98) </div> <div style="text-align: center;">  grafito (97) </div> <div style="text-align: center;">  725 </div> </div>	28,09 €	1,85 kg Vol. 0,010 m ³ Nº bultos: 1

Serie amba

Mesas compactas derecha / Postes compacts droite

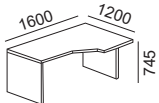
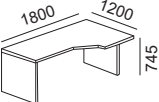
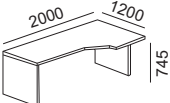
Cód. / Code	Medidas / Dimensions	P.V.P.	Packing
B 250...		178,43 €	52,89 kg Vol. 0,092 m ³ Nº bultos: 3
B 252...		197,27 €	57,22 kg Vol. 0,100 m ³ Nº bultos: 3
B 254...		215,34 €	61,33 kg Vol. 0,108 m ³ Nº bultos: 3

Mesas compactas izquierda / Postes compacts gauche

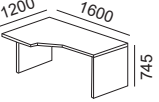
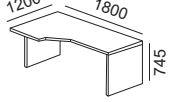
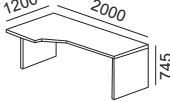
Cód. / Code	Medidas / Dimensions	P.V.P.	Packing
B 260...		178,43€	52,89 kg Vol. 0,092 m ³ Nº bultos: 3
B 262...		197,27 €	57,22 kg Vol. 0,100 m ³ Nº bultos: 3
B 264...		215,34 €	61,33 kg Vol. 0,108 m ³ Nº bultos: 3

Mesas Bench / Postes Bench

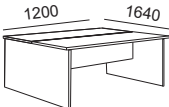
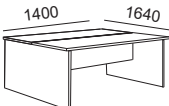
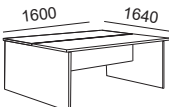
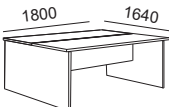
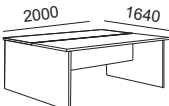



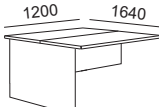
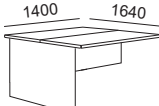
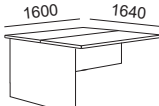
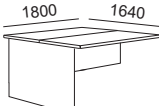
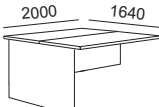



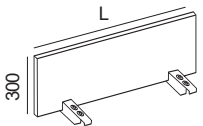

Cód. / Code	Medidas / Dimensions	P.V.P.	Packing
B 270...		275,40 €	74,00 kg Vol. 0,10 m ³ Nº bultos: 5
B 272...		295,80 €	82,00 kg Vol. 0,13 m ³ Nº bultos: 5
B 274...		316,20 €	90,00 kg Vol. 0,15 m ³ Nº bultos: 5
B 276...		336,60 €	96,00 kg Vol. 0,16 m ³ Nº bultos: 5
B 278...		357,00 €	102 kg Vol. 0,18 m ³ Nº bultos: 5

Mesas Bench extensión / Postes Bench extension









Cód. / Code	Medidas / Dimensions	P.V.P.	Packing
B 280...		229,50 €	70,00 kg Vol. 0,10 m ³ Nº bultos: 5
B 282...		249,90 €	78,00 kg Vol. 0,13 m ³ Nº bultos: 5
B 284...		270,30 €	86,00 kg Vol. 0,15 m ³ Nº bultos: 5
B 286...		290,70 €	94,00 kg Vol. 0,16 m ³ Nº bultos: 5
B 288...		311,10 €	98,00 kg Vol. 0,18 m ³ Nº bultos: 5

Serie amba



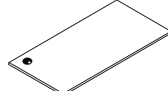
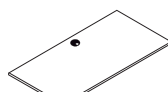
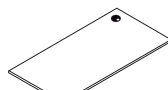

Separadores (para mesas enfrentadas, melamina 19 mm) / Séparateurs (pour postes face à face, mélamine 19 mm)

Cód. / Code	Medidas / Dimensions	Melamina / Mélamine										P.V.P.	Packing
												Ejemplo: L=1390, peral. C 708 54	
C 706...	(L=590)	56	52	60	54	53	66	68	61	51	62	24,87 €	3 kg Vol. 0,0161 m ³ Nº bultos: 1
C 704...	(L=790)	56	52	60	54	53	66	68	61	51	62	29,85 €	4 kg Vol. 0,0191 m ³ Nº bultos: 1
C 707...	(L=1190)	56	52	60	54	53	66	68	61	51	62	32,86 €	5.5 kg Vol. 0,0267 m ³ Nº bultos: 1
C 708...	(L=1390)	56	52	60	54	53	66	68	61	51	62	36,49 €	6.5 kg Vol. 0,0387 m ³ Nº bultos: 1
C 702...	(L=1590)	56	52	60	54	53	66	68	61	51	62	39,82 €	7.5 kg Vol. 0,0405 m ³ Nº bultos: 1
C 709...	(L=1790)	56	52	60	54	53	66	68	61	51	62	43,14 €	8.5 kg Vol. 0,0495 m ³ Nº bultos: 1
C 700...	(L=1990)	56	52	60	54	53	66	68	61	51	62	46,45 €	9.5 kg Vol. 0,0525 m ³ Nº bultos: 1

Accesorios / Accessoires

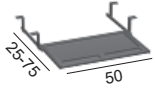
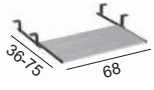
Cód. / Code	Descripción / Description	Acabados / Finitions				Imagen / Image	P.V.P.	Packing
							Ejemplo: Soporte CPU, aluminio. C 500 98	
		blanco (91/2)	aluminio (98/1)	grafito (97)	negro (4)			
C 500...	Soporte CPU Support UC	91	98	97	-		32,92 €	3,00 kg Vol. 0,020 m ³ Nº bultos: 1
C 505...	Tapón pasacables / Obturateur	-	1	-	4		3,13 €	0,02 kg Vol. 0,001 m ³ Nº bultos: 1
BL...	Mecanizado y tapón a la izquierda Mecanisée et obturateur à gauche	-	1	-	4		18,29 €	Nº bultos: 1
BM...	Mecanizado y tapón al medio Mecanisée et obturateur au milieu	-	1	-	4		18,29 €	Nº bultos: 1
BR...	Mecanizado y tapón a la derecha Mecanisée et obturateur à droite	-	1	-	4		18,29 €	Nº bultos: 1
C 501...	Gusano pasacables Câblage vertical	2	1	-	-		32,80 €	0,64 kg Vol. 0,005 m ³ Nº bultos: 1
C 503 1	Organizador pasacables Organisateur passe-cable	aluminio / aluminium					*7,57 €	0,07 kg Vol. 0,002 m ³ Nº bultos: 1
	Mesas Postes	L=800	L=1200	L=1400	L=1600	L=1800	L=2000	
	Cantidad Quantité	2	2	3	3	4	4	

* PVP unidad / PVP unité

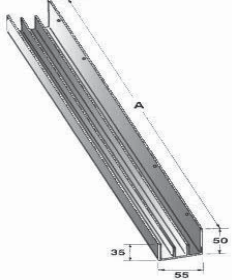
Cód. / Code	Descripción / Description	Acabados / Finitions	Imagen / Image	P.V.P.	Packing
C 507 99	Bandeja portateclado PVC Support clavier en PVC	negro / noir		31,42 €	1,50 kg Vol. 0,040 m³ Nº bultos: 1
C 508	Bandeja portateclado melamina Support clavier en mélamine	melamina / mélamine		40,96 €	2,50 kg Vol. 0,040 m³ Nº bultos: 1
33101003 00	2 tomas schuko + voz/datos 2 schuko + voix/données	negro / noir		55,00 €	Nº bultos: 1
01000003	Cable conexión a la red eléctrica (1,5 m) Câble de connexion (1,5 m)	negro / noir		12,00 €	Nº bultos: 1
44101003 98	Kit: 2 schuko+voz/datos+basket Kit: 2 schuko+voix/données+basket	schuko negro / basket aluminio schuko noir / basket aluminium		140,00 €	Nº bultos: 1
44101004 91	Mecanizado basket / mécanisé basket	-		19,50 €	-
P 79		(L=790)		5,75 €	Nº bultos: 1
P 100		(L=1000)		6,89 €	Nº bultos: 1
P 120	Pasacables en PVC Goulotte horizontale en PVC	(L=1200)		7,91 €	Nº bultos: 1
P 140		(L=1400)		9,04 €	Nº bultos: 1
P 160		(L=1600)		10,13 €	Nº bultos: 1

Detalles / Détails



Soporte CPU
Support UC



Tapón pasacables
Obtuteur



Organizador pasacables
Organisateur passe-cable



Kit: 2 tomas schuko + basket
Kit: 2 schuko + basket

Serie amba

Programa / Programme

Mesas rectas de 800 mm / Postes droits 800 mm

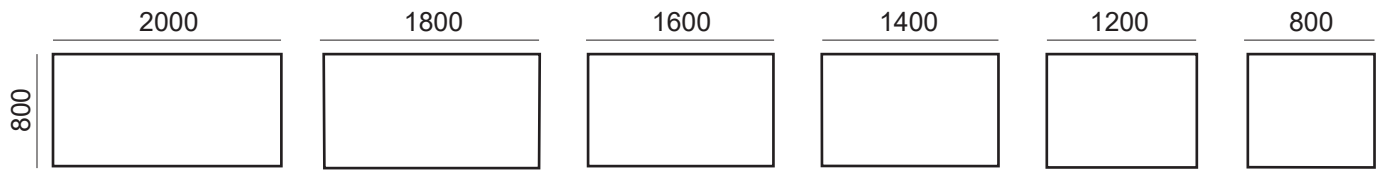

Mesas rectas de 600 mm / Postes droits 600 mm

Alas de 600 mm / Retours 600 mm

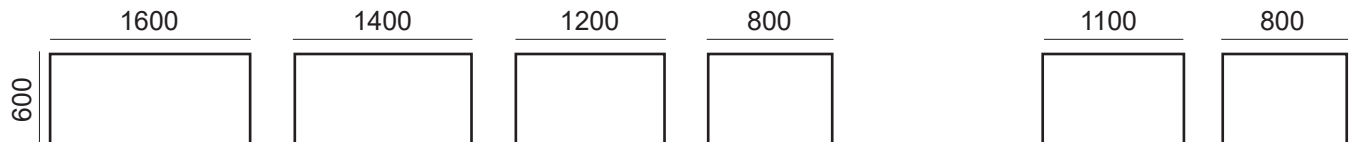

Mesas compactas / Postes compacts

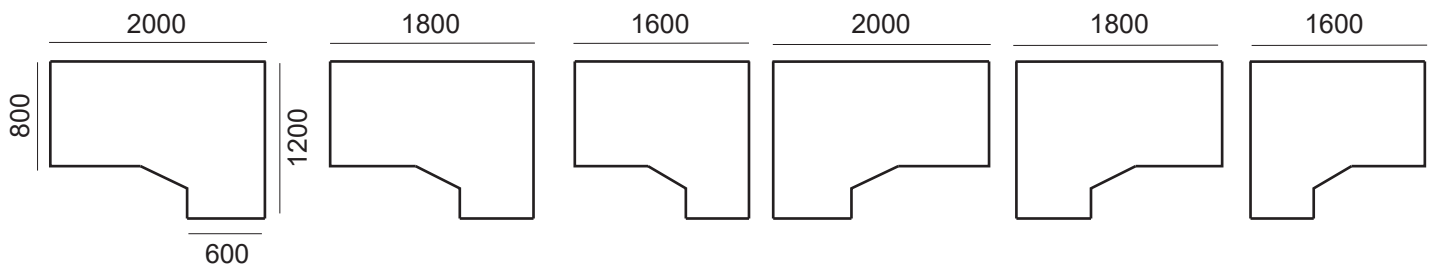

Mesas Bench / Postes Bench

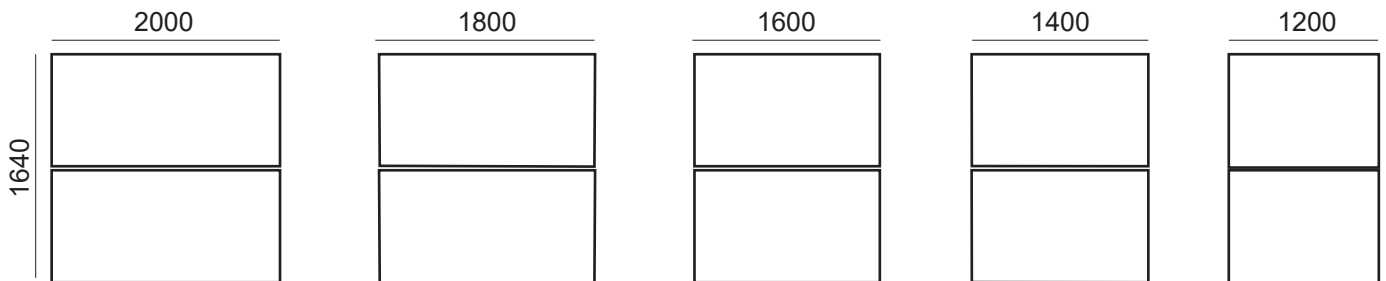

Mesas Bench extensión / Postes Bench extensión

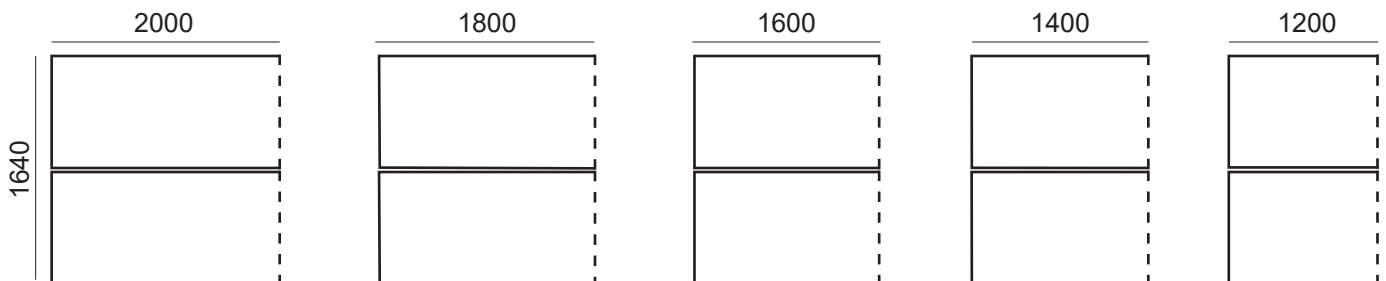

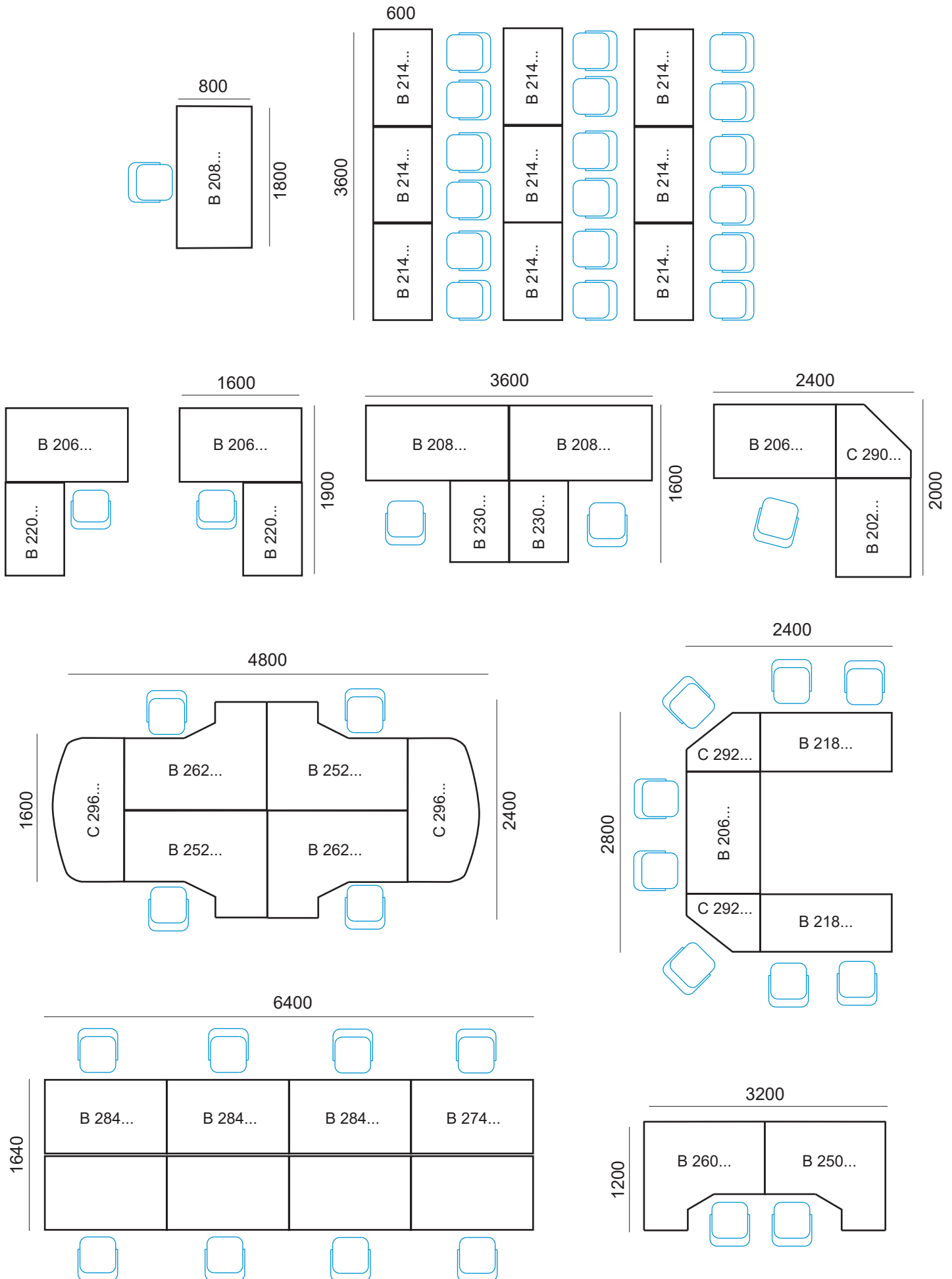

Mesas de reuniones

Ofifer 
www.ofifer.es | ofifer@ofifer.es



Mesas de reuniones / Postes de réunion

Características técnicas / Caractéristiques techniques

Disponibile en dos versiones: con estructura en melamina y con estructura metálica.

Mesa destinada tanto a ambientes de reunión como de colectividad.

Deux versions: avec structure en mélamine ou en métal.

Elles s'utilissent aussi bien pour vos espaces de réunion que pour un usage de type collectif.



Tapa / Plateau

Melamina: Tablero bilaminado de 25 mm de espesor, cantos en pvc de 2 mm de espesor.

Mélamine: Plateau épaisseur 25 mm, chant plaque 2 mm.

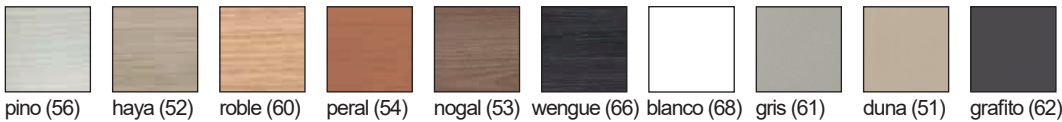

Estructura / Structure

Melamina: Tablero bilaminado de 25 mm de espesor, cantos en pvc de 2 mm de espesor.

Mélamine: Plateau épaisseur 25 mm, chant plaque 2 mm.

Mismo acabado que la tapa, ó:



Même finition que plateau, ou:

aluminio (69) grafito (62)

Metal: Acero con pintura epoxi. Acabado blanco RAL 9010, aluminio RAL 9006 y grafito.

Métal: Acier peint en epoxi. Finitions blanc RAL 9010, aluminium RAL 9006 et anthracite.



blanco (91) aluminio (98) grafito (97)
RAL 9010 RAL 9006 RAL Perso.

Programa / Programme



C 400 / C 401

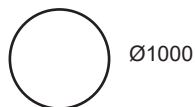

C 402 / C 403

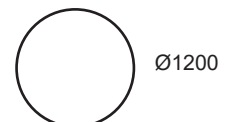

C 404 / C 405

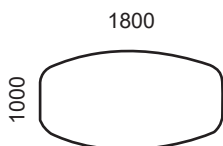

C 406 / C 407

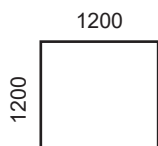

C 408 / C 409

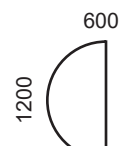

C 410

Mesas de reuniones / Postes de réunion

Código de producto / Code:

El código final del pedido vendrá determinado por la referencia del modelo, más el acabado de la tapa, la estructura, etc.

Le code d'ordre est déterminé par le référence du modèle, ainsi que la finition du plateau, des structures, etc.

Ejemplo / Exemple:

Mesa cuadrada 1200 x 1200, tapa pino, estructura grafito: **C 408 56 62**

Poste réunion 1200 x 1200, plateau pin, structure anthracite: **C 408 56 62**

Modelo / Modèle	Tapa / Plateau	Estructura / Structure
C 408	56	62

Tapa Melamina / Plateau Mélamine:



pino (56) haya (52) roble (60) peral (54) nogal (53) wengue (66) blanco (68) gris (61) duna (51) grafito (62)

Estructura Melamina / Structure Mélamine:



Mismo acabado que la tapa, ó:

Même finition que plateau, ou:



aluminio (69) grafito (62)

Mesas de reuniones (estructura de melamina) / Postes de réunion (structure en mélamine)

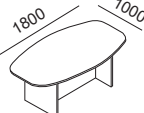
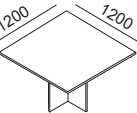
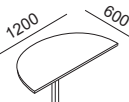
Cód. / Code	Medidas / Dimensions	P.V.P.	Packing
C 400...		137,86 €	24,85 kg Vol. 0,075 m ³ Nº bultos: 2
C 402...		147,07 €	29,30 kg Vol. 0,085 m ³ Nº bultos: 2
C 404...		151,10 €	34,61 kg Vol. 0,108 m ³ Nº bultos: 2
C 406...		193,24 €	62,13 kg Vol. 0,120 m ³ Nº bultos: 3
C 408...		159,22 €	39,37 kg Vol. 0,108 m ³ Nº bultos: 2
C 410...		82,87 €	12,92 kg Vol. 0,060 m ³ Nº bultos: 2

Mesas de reuniones / Postes de réunion

Código de producto / Code:

El código final del pedido vendrá determinado por la referencia del modelo, más el acabado de la tapa, la estructura, etc.

Le code d'ordre est déterminé par le référence du modèle, ainsi que la finition du plateau, des structures, etc.

Ejemplo / Exemple:

Mesa redonda Ø800, tapa haya, estructura aluminio: **C 401 52 98**

Poste rond Ø800, plateau hêtre, structure aluminium: **C 401 52 98**

Modelo / Modèle	Tapa / Plateau	Estructura / Structure
C 401	52	98

Tapa Melamina / Plateau Mélamine:



pino (56) haya (52) roble (60) peral (54) nogal (53) wengue (66) blanco (68) gris (61) duna (51) grafito (62)

Estructura metal / Structure métal:



blanco (91) aluminio (98) grafito (97)
RAL 9010 RAL 9006 RAL Perso.

Mesas de reuniones (estructura metálica) / Postes de réunion (structure en métal)

Cód. / Code	Medidas / Dimensions	P.V.P.	Packing
C 401...	Ø800 735	261,62 €	25,92 kg Vol. 0,063 m ³ Nº bultos: 3
C 403...	Ø1000 735	271,30 €	30,27 kg Vol. 0,070 m ³ Nº bultos: 3
C 405...	Ø1200 735	284,08 €	35,58 kg Vol. 0,072 m ³ Nº bultos: 2
C 407...	1800 1000 735	435,75 €	64,07 kg Vol. 0,137 m ³ Nº bultos: 3
C 409...	1200 1200 735	289,00 €	40,34 kg Vol. 0,086 m ³ Nº bultos: 3
C 410...	1200 600 735	82,87 €	12,92 kg Vol. 0,060 m ³ Nº bultos: 2

Composiciones de ejemplo / Compositions d'exemple

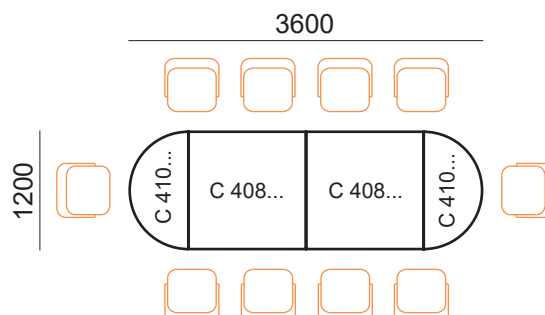

Cajoneras

Ofifer 
www.ofifer.es | ofifer@ofifer.es



Características técnicas / Caractéristiques techniques



Cajoneras melamina
Caissons en mélamine



Cajoneras metálicas
Caissons en métal

Cajoneras melamina:

Guías de extracción total de acero "sendzimir".
Cierre centralizado con llave.
5ª rueda estabilizadora para archivador rodante.

Caissons mélamine:

Guides d'extraction totale en acier "sendzimir".
Cerrure centralisée avec clés.
5ème roue pour fichier mobile.

Cajoneras metálicas:

Guías de extracción total de acero "sendzimir".
Cierre centralizado con llave.
5ª rueda estabilizadora para archivador rodante.
Estructura metálica pintada en epoxi blanco o aluminio.

Caissons en métal:

Guides d'extraction totale en acier "sendzimir".
Cerrure centralisée avec clés.
5ème roue pour fichier mobile.
Structure en métal, epoxi blanc ou aluminium.

Cajoneras melamina / Caissons en mélamine

Tapa, frontal, trasera: Tablero bilaminado, cantos en pvc.

Plateau, front, dos: Plateau mélamine, chant plaque.

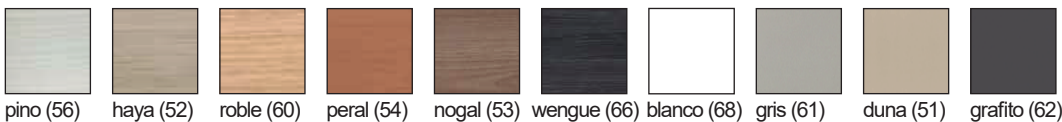

Laterales: Tablero bilaminado, cantos en pvc.

Latéraux: Plateau mélamine, chant plaque.

Mismo acabado que la tapa, ó:

Même finition que plateau, ou:

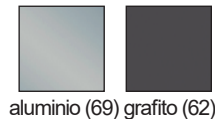

aluminio (69) grafito (62)

Cajoneras metálicas / Caissons en métal

Metal: Acero con pintura epoxi. Acabado blanco y aluminio.

Métal: Acier peint en epoxi. Finitions blanc et aluminium.

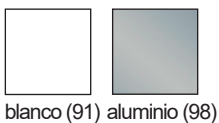

blanco (91) aluminio (98)

Programa / Programme

Melamina
Mélamine



Cajonera rodante / Caisson mobile

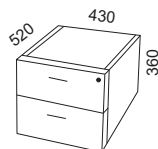

Cajonera colgante / Caisson suspendu

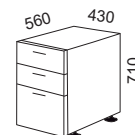

Cajonera pedestal / Caisson hauteur bureau

Metálico
En métal

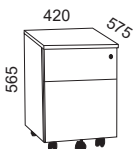

Cajonera rodante / Caisson mobile

Cajoneras / Caissons

Código de producto / Code:

El código final del pedido vendrá determinado por la referencia del modelo, más el acabado de la tapa/frontal/trasera y los laterales, etc.

Le code d'ordre est déterminé par le référence du modèle, ainsi que la finition du plateau/front/dos et des latéraux, etc.

Ejemplo / Exemple:

Cajonera rodante (1 cajón + archivador), wengue, laterales aluminio: **C 100 66 69**

Caisson mobile (1 caisson + fichier), wengue, latéraux aluminium: **C 100 66 69**

Modelo / Modèle	Tapa, frontal, trasera / Plateau, front, dos	Laterales / Latéraux
C 100	66	69

Melamina tapa, frontal, trasera / Mélamine plateau, front, dos:

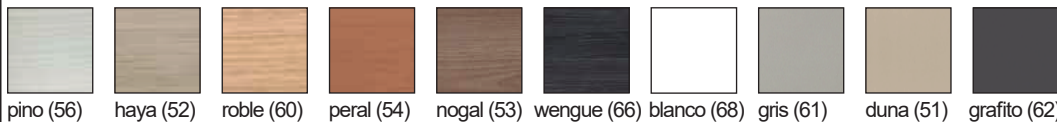

Melamina laterales / Mélamine latéraux:

Mismo acabado que la tapa, ó:

Même finition que plateau, ou:

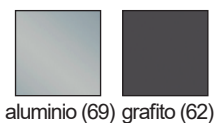

Cajonera rodante (melamina) / Caisson mobile (mélamine)

Cód. / Code	Medidas / Dimensions	Descripción / Description	P.V.P.	Packing
C 100...		Cajonera rodante (1 cajón + archivador) Caisson mobile (1 caisson + fichier)	149,81 €	23,75 kg Vol. 0,121 m ³ Nº bultos: 1
C 101...		Cajonera rodante (3 cajones) Caisson mobile (3 caissons)	141,11 €	24,10 kg Vol. 0,121 m ³ Nº bultos: 1

Cajonera colgante (melamina) / Caisson suspendu (mélamine)



Cód. / Code	Medidas / Dimensions	Descripción / Description	P.V.P.	Packing
C 102...		Cajonera colgante (2 cajones) Caisson suspendu (2 caissons)	101,28 €	15,60 kg Vol. 0,082 m ³ Nº bultos: 1

Cajonera pedestal (melamina) / Caisson hauteur bureau (mélamine)

Cód. / Code	Medidas / Dimensions	Descripción / Description	P.V.P.	Packing
C 103...		Cajonera pedestal (2 cajones + archivador) Caisson hauteur bureau (2 caissons + fichier)	211,24 €	25,10 kg Vol. 0,174 m ³ Nº bultos: 1
C 104...		Cajonera pedestal (4 cajones) Caisson hauteur bureau (4 caissons)	211,74 €	25,10 kg Vol. 0,174 m ³ Nº bultos: 1
C 105...		Sobretapa cajonera pedestal 600 (opcional) Top caisson hauteur bureau 600 (option)	21,68 €	5,01 kg Vol. 0,024 m ³ Nº bultos: 1
C 106...		Sobretapa cajonera pedestal 800 (opcional) Top caisson hauteur bureau 800 (option)	25,22 €	6,91 kg Vol. 0,033 m ³ Nº bultos: 1

Cajoneras / Caissons

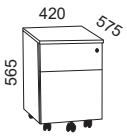
Cajonera rodante (metálica) / Caisson mobile (en métal)

Cód. / Code	Medidas / Dimensions	Descripción / Description	P.V.P.	Packing
		 blanco (91) aluminio (98)		
		Ejemplo / Exemple: Cajonera rodante metálica (3 cajones), color aluminio. Caisson mobile en métal (3 caissons), aluminium.		L 101 98
L 100...		Cajonera rodante (1 cajón + archivador) Caisson mobile (1 caisson + fichier)	225,07 €	20,80 kg Vol. 0,14 m ³ Nº bultos: 1
L 101...		Cajonera rodante (3 cajones) Caisson mobile (3 caissons)	225,07 €	20,80 kg Vol. 0,14 m ³ Nº bultos: 1

Accesorios / Accessoires

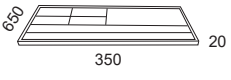
Cód. / Code	Medidas / Dimensions	Descripción / Description	P.V.P.	Packing
L 149		Bandeja portalapiceros de PVC negro Plumier en PVC noir	8,85 €	0,40 kg Vol. 0,03 m ³ Nº bultos: 1

Armarios

Ofifer 
www.ofifer.es | ofifer@ofifer.es



Características técnicas / Caractéristiques techniques

Armarios disponibles en 4 alturas: H=745 mm, H=1345 mm, H=1965 mm, H=2395 mm.

Laterales de melamina 19 mm.

Trasera de melamina 10 mm.

Tapa armarios de melamina 25 mm.

Puertas de 19 mm con cerradura incorporada y varilla de aluminio (excepto armarios con puerta de cristal).

Armoires disponibles en 4 hauteurs: H=745 mm, H=1345 mm, H=1965 mm, H=2395 mm.

Latéraux réalisée en mélamine, épaisseur 19 mm.

Dos réalisée en mélamine, épaisseur 10 mm.

Tops réalisée en mélamine, épaisseur 25 mm.

Portes épaisseur 19 mm avec serrure et traingle en aluminium (sauf les armoires avec portes vitrées avec cadre).



Tapa, puertas y trasera / Plateau, portes et dos

Melamina: Tablero bilaminado, cantos en pvc.

Mélamine: Tableau en mélamine, chant plaque.

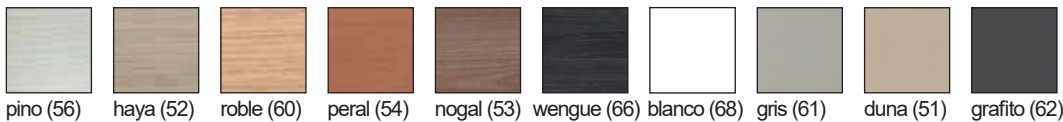

Puertas de cristal: 4 mm.

Portes en verre: 4 mm.



Laterales / Latéraux

Melamina: Tablero bilaminado de 19 mm de espesor, cantos en pvc de 1 mm de espesor.

Mélamine: Latéraux épaisseur 19 mm, chant plaque 1 mm.

Mismo acabado que la tapa, ó:

Même finition que plateau, ou:

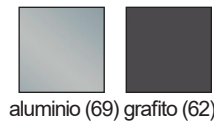

Detalles / Détails



1



2



3



4

1: Protección antihumedad de poliestireno. / Protection anti-humidité Polystyrène.

2: Tiradores en PVC. / Poignées en PVC.

3: Puertas de cristal mate 4 mm, con marco de aluminio. / Portes en verre depoli 4 mm, avec cadre en aluminium.

4: Guía de archivadores de extracción total con sistema antivuelco. / Glissières ouverture 100% sur les tiroirs pour dossiers suspendus.

Programa / Programme

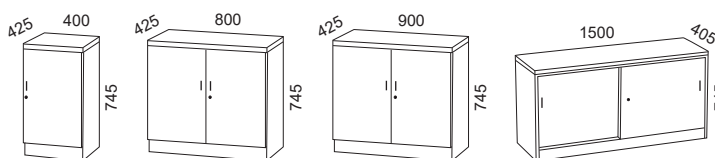

Armarios H=745 / Armoires H=745

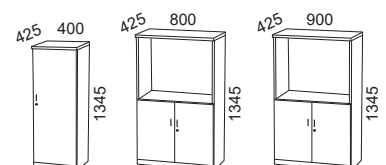

Armarios H=1345 / Armoires H=1345

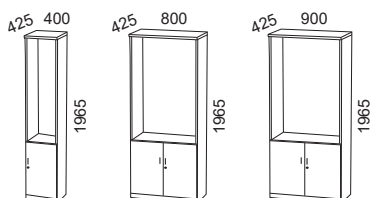

Armarios H=1965 / Armoires H=1965

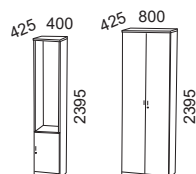

Armarios H=2395 / Armoires H=2395

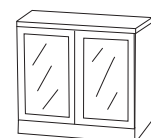

Puertas de cristal / Portes en verre

Armarios / Armoires

Código de producto / Code:

El código final del pedido vendrá determinado por la referencia del modelo, más el acabado de la tapa/puerta/trasera y los laterales, etc.

Le code d'ordre est déterminé par le référence du modèle, ainsi que la finition du plateau/porte/dos et des latéraux, etc.

Ejemplo / Exemple:

Armario de 745 x 800 x 425, tapa/puerta/trasera roble, laterales aluminio: **C 301 60 69**

Armoire 745 x 800 x 425, plateau/porte/dos chêne, latéraux aluminium: **C 301 60 69**

Modelo / Modèle	Tapa, puerta, trasera / Plateau, porte, dos	Laterales / Latéraux
C 301	60	69

Melamina tapa, puerta, trasera / Mélamine plateau, porte, dos:

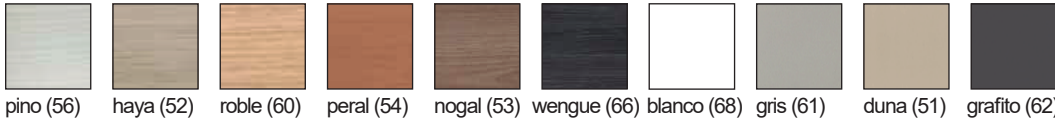

Melamina laterales / Mélamine latéraux:

Mismo acabado que la tapa, ó:









Même finition que plateau, ou:

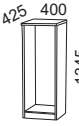

Armarios H=745 mm (estantes no incluidos, ver pág.87) / Armoires H=745 mm (tablettes non inclus, aller page 87)

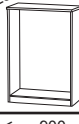

Cód. / Code	Medidas / Dimensions	Descripción / Description	P.V.P.	Packing
C 303...		Armario reducido vacío Armoire réduit vide	71,95 €	15,06 kg Vol. 0,032 m³ Nº bultos: 3
C 304...		Armario reducido con puerta Armoire réduit avec porte	107,12 €	18,26 kg Vol. 0,040 m³ Nº bultos: 3
C 300...		Armario vacío Armoire vide	83,47 €	22,65 kg Vol. 0,050 m³ Nº bultos: 3
C 301...		Armario con puertas Armoire avec portes	130,74 €	29,05 kg Vol. 0,065 m³ Nº bultos: 4
C 302...		Armario con archivadores Armoire avec 2 D.S.	409,79 €	49,40 kg Vol. 0,271 m³ Nº bultos: 1
C 370...		Armario vacío Armoire vide	102,80 €	22,65 kg Vol. 0,050 m³ Nº bultos: 3
C 371...		Armario con puertas Armoire avec portes	156,76 €	29,05 kg Vol. 0,065 m³ Nº bultos: 4
C 305...		Armario CRD Armoire CRD	308,58 €	59,76 kg Vol. 0,476 m³ Nº bultos: 1

Armarios H=1345 mm (estantes no incluidos, ver pág.87) / Armoires H=1345 mm (tablettes non inclus, aller page 87)

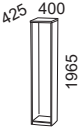
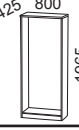
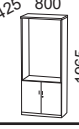
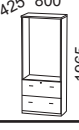

Cód. / Code	Medidas / Dimensions	Descripción / Description	P.V.P.	Packing
C 314...		Armario reducido vacío Armoire reduit vide	90,91 €	22,80 kg Vol. 0,048 m ³ Nº bultos: 3
C 315...		Armario reducido vacío con puerta Armoire reduit vide avec porte	140,77 €	29,03 kg Vol. 0,063 m ³ Nº bultos: 4
C 316...		Archivador vertical con 4 cajonex duplex Classeur 4 tiroirs	436,55 €	62,04 kg Vol. 0,467 m ³ Nº bultos: 1
C 310...		Armario vacío Armoire vide	107,13 €	32,01 kg Vol. 0,069 m ³ Nº bultos: 3
C 311...		Armario con puertas bajas Armoire avec portes bass	172,64 €	44,44 kg Vol. 0,094 m ³ Nº bultos: 5
C 312...		Armario con archivadores Armoire avec 2 D.S.	469,75 €	64,49 kg Vol. 0,485 m ³ Nº bultos: 1
C 313...		Armario con puertas Armoire avec portes	181,76 €	46,47 kg Vol. 0,098 m ³ Nº bultos: 4
C 372...		Armario vacío Armoire vide	134,85 €	35,01 kg Vol. 0,069 m ³ Nº bultos: 3
C 374...		Armario con puertas bajas Armoire avec portes bass	236,06 €	46,47 kg Vol. 0,099 m ³ Nº bultos: 5
C 373...		Armario con puertas Armoire avec portes	238,46 €	44,47 kg Vol. 0,098 m ³ Nº bultos: 4

Armarios / Armoires

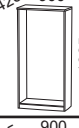
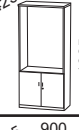
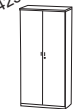
Armarios H=1965 mm (estantes no incluidos, ver pág.87) / Armoires H=1965 mm (tablettes non inclus, aller page 87)

Cód. / Code	Medidas / Dimensions	Descripción / Description	P.V.P.	Packing
C 324...		Armario reducido vacío Armoire réduit vide	112,93 €	30,81 kg Vol. 0,064 m ³ Nº bultos: 3
C 325...		Armario reducido con puerta baja Armoire réduit avec porte bas	153,74 €	34,00 kg Vol. 0,079 m ³ Nº bultos: 5
C 326...		Armario reducido con puerta Armoire réduit avec porte	164,96 €	37,04 kg Vol. 0,079 m ³ Nº bultos: 4
C 320...		Armario vacío Armoire vide	138,95 €	41,69 kg Vol. 0,088 m ³ Nº bultos: 3
C 321...		Armario con puertas bajas Armoire avec portes bass	193,76 €	54,11 kg Vol. 0,113 m ³ Nº bultos: 5
C 322...		Armario con archivadores Armoire avec 2 D.S.	496,02 €	74,04 kg Vol. 0,706 m ³ Nº bultos: 1
C 323...		Armario con puertas Armoire avec portes	216,10 €	60,41 kg Vol. 0,103 m ³ Nº bultos: 4
C 375...		Armario vacío Armoire vide	157,51 €	43,69 kg Vol. 0,088 m ³ Nº bultos: 3
C 377...		Armario con puertas bajas Armoire avec portes bass	244,80 €	56,11 kg Vol. 0,120 m ³ Nº bultos: 5
C 376...		Armario con puertas Armoire avec portes	274,22 €	63,41 kg Vol. 0,103 m ³ Nº bultos: 4

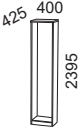
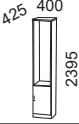
Armarios H=2395 mm (estantes no incluidos, ver pág.87) / Armoires H=2395 mm (tablettes non inclus, aller page 87)

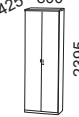
Cód. / Code	Medidas / Dimensions	Descripción / Description	P.V.P.	Packing
C 332...		Armario reducido vacío Armoire réduit vide	156,66 €	35,55 kg Vol. 0,077 m ³ Nº bultos: 3
C 333...		Armario reducido con puerta baja Armoire réduit avec porte bas	196,98 €	49,79 kg Vol. 0,085 m ³ Nº bultos: 5
C 330...		Armario vacío Armoire vide	165,43 €	50,79 kg Vol. 0,110 m ³ Nº bultos: 3
C 331...		Armario con puertas Armoire avec portes	268,53 €	76,60 kg Vol. 0,130 m ³ Nº bultos: 4

Armarios / Armoires

Código de producto / Code:

El código final del pedido vendrá determinado por la referencia del modelo, más el acabado de la tapa/trasera y los laterales, etc.

Le code d'ordre est déterminé par le référence du modèle, ainsi que la finition du plateau/dos et des latéraux, etc.

Ejemplo / Exemple:

Armario con puertas de cristal de 745 x 800 x 425, tapa/trasera wengue, laterales aluminio: **C 340 66 69**

Modelo / Tapa, trasera / Laterales /
Modèle / Plateau, dos / Latéraux

Armoire portes en verre 745 x 800 x 425, plateau/dos wengue, latéraux aluminium: **C 340 66 69**

C 340 66 69

Melamina tapa, trasera / Mélamine plateau, dos:

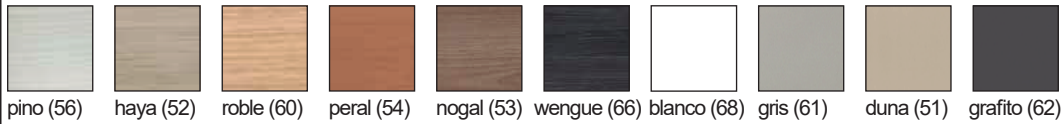

Puertas de cristal mate 4 mm, marco aluminio
Portes en verre depoli 4 mm, cadre en aluminium



mate

Melamina laterales / Mélamine latéraux:

Mismo acabado que la tapa, ó:



Même finition que plateau, ou:



aluminio (69) grafito (62)

Armarios con puertas de cristal (sin cerradura) / Armoires avec portes en verre (sans serrure)

Cód. / Code	Medidas / Dimensions	Descripción / Description	P.V.P.	Packing
C 340...		Armario con puertas de cristal Armoire avec portes en verre	296,91 €	29,05 kg Vol. 0,065 m ³ Nº bultos: 5
C 341...		Armario con puertas de cristal Armoire avec portes en verre	394,22 €	44,47 kg Vol. 0,098 m ³ Nº bultos: 5
C 344...		Armario reducido con puerta de cristal Armoire réduit avec porte en verre	359,00 €	37,04 kg Vol. 0,079 m ³ Nº bultos: 4
C 342...		Armario con puertas bajas de cristal Armoire avec portes bass en verre	379,45 €	54,11 kg Vol. 0,113 m ³ Nº bultos: 6
C 343...		Armario con puertas de cristal Armoire avec portes en verre	504,11 €	60,41 kg Vol. 0,103 m ³ Nº bultos: 5

Armarios / Armoires

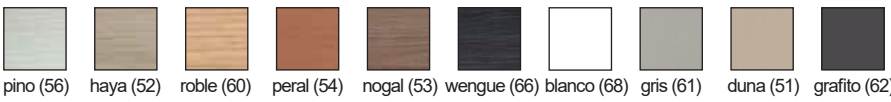
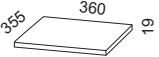
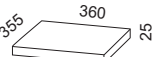
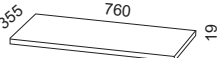
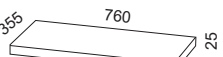
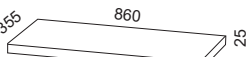
Estantes de armario / Tablettes d'armoire

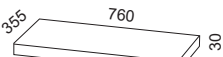
Cód. / Code	Medidas / Dimensions	Descripción / Description	P.V.P.	Packing
		<p>Ejemplo / Exemple: Estante melamina, para armario ancho 800 mm, espesor 19 mm, color pino. Tablette en mélamine, pour armoire largeur 800 mm, épaisseur 19 mm, pin.</p>		C 360 56
C 362...		Estante melamina, para armario ancho 400 mm, espesor 19 mm Tablette en mélamine, pour armoire largeur 400, épaisseur 19	8,37 €	1,70 kg Vol. 0,004 m ³ Nº bultos: 1
C 363...		Estante melamina, para armario ancho 400 mm, espesor 25 mm Tablette en mélamine, pour armoire largeur 400, épaisseur 25	9,83 €	2,60 kg Vol. 0,004 m ³ Nº bultos: 1
C 360...		Estante melamina, para armario ancho 800 mm, espesor 19 mm Tablette en mélamine, pour armoire largeur 800, épaisseur 19	12,36 €	3,52 kg Vol. 0,008 m ³ Nº bultos: 1
C 361...		Estante melamina, para armario ancho 800 mm, espesor 25 mm Tablette en mélamine, pour armoire largeur 800, épaisseur 25	15,39 €	5,40 kg Vol. 0,008 m ³ Nº bultos: 1
C 366...		Estante melamina, para armario ancho 900 mm, espesor 25 mm Tablette en mélamine, pour armoire largeur 900, épaisseur 25	21,56 €	6,20 kg Vol. 0,008 m ³ Nº bultos: 1
C 364...	 	Estante metálico para colgar carpetas, para armario ancho 800 mm Tablette en métal pour dossiers suspendus, pour armoire largeur 800	20,52 €	1,50 kg Vol. 0,002 m ³ Nº bultos: 1

Accesorios / Accessoires

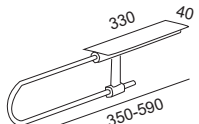
Cód. / Code	Medidas / Dimensions	Descripción / Description	P.V.P.	Packing
C 365...	 	Portaperchas metálico extensible Penderie en métal	13,07 €	0,50 kg Vol. 0,002 m ³ Nº bultos: 1

Estanterías

Ofifer 
www.ofifer.es | ofifer@ofifer.es



Características técnicas / Caractéristiques techniques

Estanterías disponibles en 2 alturas: H=1345 mm y H=2395 mm.
Laterales de melamina 25 mm.
Estantes de melamina 25 mm.
Refuerzos de melamina 19 mm.

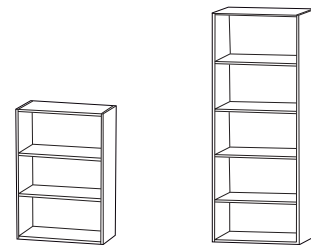

Rayonnages disponibles en 2 hauteurs: H=1345 mm y H=2395 mm.
Latéraux réalisée en mélamine, épaisseur 25 mm.
Tablettes réalisée en mélamine, épaisseur 25 mm.
Renforcement réalisée en mélamine, épaisseur 19 mm.

Laterales / Latéraux

Melamina: Tablero bilaminado de 25 mm de espesor, cantos en pvc de 2 mm de espesor.
Mélamine: Latéraux épaisseur 25 mm, chant plaque 2 mm.

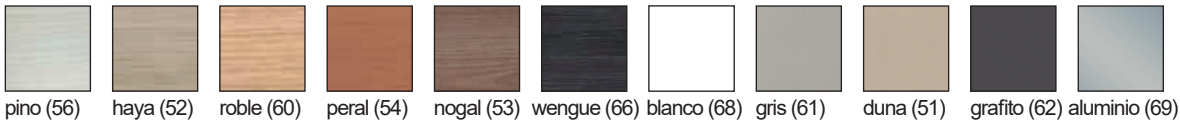

Estantes / Tablettes

Melamina: Tablero bilaminado de 25 mm de espesor, cantos en pvc de 2 mm de espesor.
Mélamine: Latéraux épaisseur 25 mm, chant plaque 2 mm.

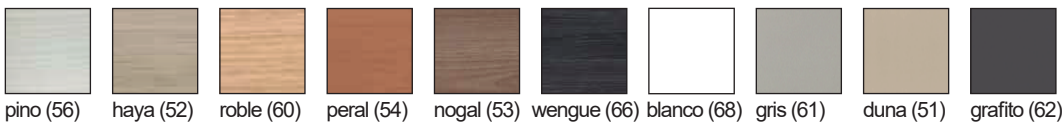

Detalles / Détails



1

1: Protección antihumedad de poliestireno. / Protection anti-humidité Polystyrène.

Programa / Programme

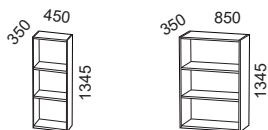

Estanterías H=1345 / Rayonnages H=1345

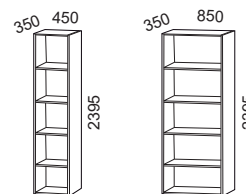

Estanterías H=2395 / Rayonnages H=2395

Estanterías / Rayonnages

Código de producto / Code:

El código final del pedido vendrá determinado por la referencia del modelo, más el acabado de los laterales, etc.

Le code d'ordre est déterminé par le référence du modèle, ainsi que la finition des latéraux, etc.

Ejemplo / Exemple:

Estantería de 1345 x 850 x 350, laterales peral: **C 352 54**

Rayonnages 1345 x 850 x 350, latéraux poirier: **C 352 54**

Modelo /
Modèle

Laterales /
Latéraux

C 352

54

Laterales:



pino (56)



haya (52)



roble (60)



peral (54)



nogal (53)



wengue (66)



blanco (68)



gris (61)



duna (51)



grafito (62)



aluminio (69)

Estanterías H=1345 mm (estantes no incluidos, ver pág.91) / Rayonnages H=1345 mm (tablettes non inclus, aller page 91)

Cód. / Code	Medidas / Dimensions	Descripción / Description	P.V.P.	Packing
C 356...		Estantería ancho 450 mm Rayonnage largeur 450 mm	62,78 €	20,34 kg Vol. 0,024 m ³ Nº bultos: 2
C 357...		Extensión para estantería ancho 450 mm Extension pour rayonnage largeur 450 mm	32,64 €	10,95 kg Vol. 0,017 m ³ Nº bultos: 2
C 352...		Estantería ancho 850 mm Rayonnage largeur 850 mm	63,74 €	20,86 kg Vol. 0,026 m ³ Nº bultos: 3
C 353...		Extensión para estantería ancho 850 mm Extension pour rayonnage largeur 850 mm	33,72 €	11,47 kg Vol. 0,018 m ³ Nº bultos: 2

Estanterías H=2395 mm (estantes no incluidos, ver pág.91) / Rayonnages H=2395 mm (tablettes non inclus, aller page 91)

Cód. / Code	Medidas / Dimensions	Descripción / Description	P.V.P.	Packing
C 354...		Estantería ancho 450 mm Rayonnage largeur 450 mm	111,56 €	31,98 kg Vol. 0,071 m ³ Nº bultos: 3
C 355...		Extensión para estantería ancho 450 mm Extension pour rayonnage largeur 450 mm	56,68 €	16,86 kg Vol. 0,037 m ³ Nº bultos: 2
C 350...		Estantería ancho 850 mm Rayonnage largeur 850 mm	115,08 €	34,76 kg Vol. 0,078 m ³ Nº bultos: 3
C 351...		Extensión para estantería ancho 850 mm Extension pour rayonnage largeur 850 mm	56,94 €	17,38 kg Vol. 0,039 m ³ Nº bultos: 2

Estanterías / Rayonnages

Estantes de estanterías / Tablettes de rayonnages

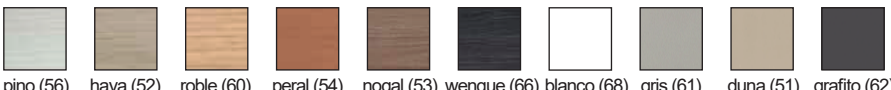
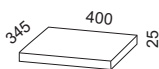
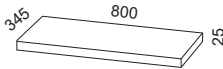
Cód. / Code	Medidas / Dimensions	Descripción / Description	P.V.P.	Packing
 <p>pino (56) haya (52) roble (60) peral (54) nogal (53) wengue (66) blanco (68) gris (61) duna (51) grafito (62)</p>		<p>Ejemplo / Exemple: Estante para estantería ancho 850 mm, color blanco. Tablette pour rayonnage largeur 850 mm, blanc.</p>		C 358 68
C 359...		<p>Estante para estantería ancho 450 mm Tablette pour rayonnage largeur 450 mm</p>	14,12 €	2,12 kg Vol. 0,008 m ³ N° bultos: 1
C 358...		<p>Estante para estantería ancho 850 mm Tablette pour rayonnage largeur 850 mm</p>	21,28 €	4,24kg Vol. 0,015 m ³ N° bultos: 1

Gama de colores bilaminados

La gama de colores puede sufrir alguna variación en la tonalidad debido al proceso de impresión y del ajuste cromático de su monitor, toda nuestra gama son acabados mate

