



ESTEHYNE S.L.

ESPECIALISTAS EN HIDRAULICA Y NEUMATICA

MANOMETROS

TARIFA-2019



WWW.hidraulicaneumatica.es



Ø 40	1/8" BSPP RADIAL		1/8" BSPP POST.	
	CLASE 1,6 SIN GLICERINA REL.		CLASE 1,6 SIN GLICERINA REL.	
				
ESCALA BAR	CODIGO	TARIFA	CODIGO	TARIFA
0/1,6	6081181100	13,92	6081281100	14,41
0/2,5	6081181200	13,92	6081281200	14,41
0/4	6081181300	13,92	6081281300	14,41
0/6	6081181400	13,92	6081281400	14,41
0/10	6081181500	13,92	6081281500	14,41
0/16	6081181600	13,92	6081281600	14,41
0/25	6081181700	13,92	6081281700	14,41
0/40	6081181800	13,92	6081281800	14,41
0/315			6081282300	14,41

Ø 50	1/4" BSPP RADIAL		1/4" BSPP POST.	
	CLASE 1,6 SIN GLICERINA REL.		CLASE 1,6 SIN GLICERINA REL.	
				
ESCALA BAR	CODIGO	TARIFA	CODIGO	TARIFA
-1/0	6082140800	14,66	6082240800	14,22
0/1	6082141000	14,66	6082241000	14,22
0/1,6	6082141100	14,66	6082241100	14,22
0/2,5	6082141200	14,66	6082241200	14,22
0/4	6082141300	14,66	6082241300	14,22
0/6	6082141400	14,66	6082241400	14,22
0/10	6082141500	11,68	6082241500	14,22
0/16	6082141600	11,68	6082241600	14,22
0/25	6082141700	11,68	6082241700	14,22
0/40	6082141800	14,66	6082241800	14,22
0/60	6082141900	14,66	6082241900	14,22
0/100	6082142000	14,66	6082242000	14,22
0/160	6082142100	14,66	6082242100	14,22
0/250	6082142200	14,66	6082242200	14,22
0/315	6082142300	14,66	6082242300	14,22
0/400	6082142400	14,66	6082242400	14,22

Ø 63	1/4" BSPP RADIAL		1/4" BSPP POST.	
	CLASE 1,6 CON GLICERINA		CLASE 1,6 CON GLICERINA	
				
ESCALA BAR	CODIGO	TARIFA	CODIGO	TARIFA
-1/+0,6	6053140100	13,01	6063240100	14,69
-1/+1,5	6053140200	13,01	6063240200	14,69
-1/+3	6053140300	13,01	6063240300	14,69
-1/+5	6053140400	13,01	6063240400	14,69
-1/+9	6053140500	13,01	6063240500	14,69
-1/+15	6053140600	13,01		
-1/+24	6053140700	13,01		
-1/0	6053140801	13,01	6063240801	14,69
0/0,6	6053140900	18,85	6063240900	20,88
0/1	6053141000	13,01	6063241000	14,69
0/1,6	6053141100	13,01	6063241100	14,69
0/2,5	6053141200	11,68	6063241200	13,42
0/4	6053141300	11,68	6063241300	13,42
0/6	6053141400	11,68	6063241400	13,42
0/10	6053141500	11,68	6063241500	13,42
0/16	6053141600	11,68	6063241600	13,42
0/25	6053141700	11,68	6063241700	13,42
0/40	6053141800	11,68	6063241800	13,42
0/60	6053141900	11,68	6063241900	13,42
0/100	6053142000	13,01	6063242000	14,69
0/160	6053142100	13,01	6063242100	14,69
0/250	6053142200	13,01	6063242200	14,69
0/315	6053142300	13,01	6063242300	14,69
0/400	6053142400	17,72	6063242400	17,75
0/600	6053142500	17,72	6063242500	17,75
0/1000	6053142600	17,72	6063242600	17,75

Ø 63	1/4" BSPP RADIAL		1/4" BSPP POST.	
	CLASE 1,6 SIN GLICERINA REL.		CLASE 1,6 SIN GLICERINA REL.	
				
ESCALA BAR	CODIGO	TARIFA	CODIGO	TARIFA
-1/+0,6	6083140100	13,01	6083240100	14,69
-1/+1,5	6083140200	13,01	6083240200	14,69
-1/+3	6083140300	13,01	6083240300	14,69
-1/+5	6083140400	13,01	6083240400	14,69
-1/+9	6083140500	13,01	6083240500	14,69
-1/+15	6083140600	13,01	6083240600	14,69
-1/+24	6083140700	13,01	6083240700	14,69
-1/0	6083140800	13,01	6083240800	14,69
0/0,6	6083140900	18,85	6083240900	20,88
0/1	6083141000	13,01	6083241000	14,69
0/1,6	6083141100	13,01	6083241100	14,69
0/2,5	6083141200	11,68	6083241200	13,42
0/4	6083141300	11,68	6083241300	13,42
0/6	6083141400	11,68	6083241400	13,42
0/10	6083141500	11,68	6083241500	13,42
0/16	6083141600	11,68	6083241600	13,42
0/25	6083141700	11,68	6083241700	13,42
0/40	6083141800	11,68	6083241800	13,42
0/60	6083141900	11,68	6083241900	13,42
0/100	6083142000	13,01	6083242000	14,69
0/160	6083142100	13,01	6083242100	14,69
0/250	6083142200	13,01	6083242200	14,69
0/315	6083142300	13,01	6083242300	14,69
0/400	6083142400	17,72	6083242400	17,75
0/600	6083142500	17,72	6083242500	17,75
0/1000	6083142600	17,72	6083242600	17,75



Ø 100	1/2" BSPP RADIAL		1/2" BSPP POST.	
	CLASE 1,6 CON GLICERINA		CLASE 1,6 CON GLICERINA	
ESCALA BAR	CODIGO	TARIFA	CODIGO	TARIFA
-1/+0,6	6055120100	38,48		
-1/+1,5	6055120200	38,48		
-1/+3	6055120300	38,48	6065220300	43,25
-1/+5	6055120400	38,48		
-1/+9	6055120500	38,48		
-1/+15	6055120600	38,48		
-1/+24	6055120700	38,48		
-1/0	6055120801	38,48	6065220800	43,25
0/0,6	6055120900	38,48		
0/1	6055121000	38,48	6065221000	43,25
0/1,6	6055121100	38,48		
0/2,5	6055121200	32,08	6065221200	43,25
0/4	6055121300	32,08	6065221300	37,69
0/6	6055121400	32,08	6065221400	37,69
0/10	6055121500	32,08	6065221500	37,69
0/16	6055121600	32,08	6065221600	37,69
0/25	6055121700	32,08	6065221700	37,69
0/40	6055121800	32,08	6065221800	37,69
0/60	6055121900	32,08	6065221900	37,69
0/100	6055122000	32,08	6065222000	37,69
0/160	6055122100	32,08	6065222100	37,69
0/250	6055122200	32,08	6065222200	37,69
0/315	6055122300	32,08	6065222300	37,69
0/400	6055122400	38,48	6065222400	43,25
0/600	6055122500	38,48	6065222500	43,25
0/1000	6055122600	51,73	6065222600	54,00

Ø 100	1/2" BSPP RADIAL		1/2" BSPP POST.	
	CLASE 1 SIN GLICERINA RELL		CLASE 1 SIN GLICERINA RELL	
ESCALA BAR	CODIGO	TARIFA	CODIGO	TARIFA
-1/+0,6	6175120100	49,14	6175220100	49,14
-1/+1,5	6175120200	49,14	6175220200	49,14
-1/+3	6175120300	49,14	6175220300	49,14
-1/+5	6175120400	49,14	6175220400	49,14
-1/+9	6175120500	49,14	6175220500	49,14
-1/+15	6175120600	49,14	6175220600	49,14
-1/+24	6175120700	49,14	6175220700	49,14
-1/0	6175120800	49,14	6175220800	49,14
0/0,6	6175120900	49,14	6175220900	49,14
0/1	6175121000	46,02	6175221000	46,02
0/1,6	6175121100	46,02	6175221100	46,02
0/2,5	6175121200	46,02	6175221200	46,02
0/4	6175121300	46,02	6175221300	46,02
0/6	6175121400	46,02	6175221400	46,02
0/10	6175121500	46,02	6175221500	46,02
0/16	6175121600	46,02	6175221600	46,02
0/25	6175121700	46,02	6175221700	46,02
0/40	6175121800	46,02	6175221800	46,02
0/60	6175121900	49,14	6175221900	49,14
0/100	6175122000	49,14	6175222000	49,14
0/160	6175122100	49,14	6175222100	49,14
0/250	6175122200	49,14	6175222200	49,14
0/315	6175122300	49,14	6175222300	49,14
0/400	6175122400	49,14	6175222400	49,14
0/600	6175122500	49,14	6175222500	49,14
0/1000	6175122600	49,14		

Ø 150	1/2" BSPP RADIAL	
	CLASE 1 SIN GLICERINA RELL	
ESCALA BAR	CODIGO	TARIFA
-1/+0,6	6176120100	106,16
-1/+1,5	6176120200	106,16
-1/+3	6176120300	106,16
-1/+5	6176120400	106,16
-1/+9	6176120500	106,16
-1/+15	6176120600	106,16
-1/+24	6176120700	106,16
-1/0	6176120800	94,51
0/0,6	6176120900	106,16
0/1	6176121000	94,51
0/1,6	6176121100	94,51
0/2,5	6176121200	94,51
0/4	6176121300	94,51
0/6	6176121400	94,51
0/10	6176121500	94,51
0/16	6176121600	94,51
0/25	6176121700	94,51
0/40	6176121800	94,51
0/60	6176121900	106,16
0/100	6176122000	106,16
0/160	6176122100	106,16
0/250	6176122200	106,16
0/315	6176122300	106,16
0/400	6176122400	106,16
0/600	6176122500	106,16
0/1000	6176122600	106,16

	CARGA DE GLICERINA	PRECIOS NETOS
	Ø40 / Ø50 / Ø63	6319300000 2,58
	Ø100	6319500000 4,77
	Ø150	6319600000 9,72

	BORDE FRONTAL	CODIGO	TARIFA
	Ø40 608118	6071000001	3,89
	Ø50 608214	6072000001	3,89
	Ø63 606324 / 608314	6070000001	4,16
	Ø63 INOX	6070100001	6,90
	Ø100 60652	6075000001	16,28
	Ø100 617512 / INOX	6075100001	17,72
	Ø150 INOX	6076100001	31,10

	BRIDA TRASERA	CODIGO	TARIFA
	Ø40 608128	6071000002	4,52
	Ø50 608224	6072000002	4,52
	Ø63 PARA 606324 / 608314	6070000002	4,52
	Ø100 PARA 60652	6075000002	18,32

	PRECIOS NETOS
CERTIFICADO DE CALIB.	6300100000 15,02
CERTIFICADO ENAC HASTA 600 BAR	6300200000 181,41
CERTIFICADO ENAC HASTA 1600 BAR	6300200100 221,52
DESENGRASADO PARA OXÍGENO	6310000001 17,47









	MANOMETRO TODO INOX SIN GLICERINA, RELLENABLE TOMA RADIAL BSPP						
	CLASE 1,6		CLASE 1		CLASE 1		
	Ø63	1/4"	Ø100	1/2"	Ø150	1/2"	
ESCALA BAR	CODIGO	TARIFA	CODIGO	TARIFA	CODIGO	TARIFA	ESCALA BAR
-1/+0,6	6163140100	30,46	6165120100	66,32	6166120100	115,37	-1/+0,6
-1/+1,5	6163140200	30,46	6165120200	66,32	6166120200	115,37	-1/+1,5
-1/+3	6163140300	30,46	6165120300	66,32	6166120300	115,37	-1/+3
-1/+5	6163140400	30,46	6165120400	66,32	6166120400	115,37	-1/+5
-1/+9	6163140500	30,46	6165120500	66,32	6166120500	115,37	-1/+9
-1/+15	6163140600	30,46	6165120600	66,32	6166120600	115,37	-1/+15
-1/+24	6163140700	30,46	6165120700	66,32	6166120700	115,37	-1/+24
-1/0	6163140800	25,98	6165120800	64,06	6166120800	115,37	-1/0
0/0,6			6165120900	66,32	6166120900	115,37	0/0,6
0/1	6163141000	25,98	6165121000	64,06	6166121000	115,37	0/1
0/1,6	6163141100	25,98	6165121100	64,06	6166121100	115,37	0/1,6
0/2,5	6163141200	25,98	6165121200	64,06	6166121200	94,83	0/2,5
0/4	6163141300	25,98	6165121300	64,06	6166121300	94,83	0/4
0/6	6163141400	25,98	6165121400	64,06	6166121400	94,83	0/6
0/10	6163141500	25,98	6165121500	64,06	6166121500	94,83	0/10
0/16	6163141600	25,98	6165121600	64,06	6166121600	94,83	0/16
0/25	6163141700	25,98	6165121700	64,06	6166121700	94,83	0/25
0/40	6163141800	25,98	6165121800	64,06	6166121800	94,83	0/40
0/60	6163141900	25,98	6165121900	64,06	6166121900	115,37	0/60
0/100	6163142000	25,98	6165122000	64,06	6166122000	115,37	0/100
0/160	6163142100	25,98	6165122100	64,06	6166122100	115,37	0/160
0/250	6163142200	25,98	6165122200	64,06	6166122200	115,37	0/250
0/315	6163142300	25,98	6165122300	64,06	6166122300	115,37	0/315
0/400	6163142400	30,46	6165122400	64,06	6166122400	115,37	0/400
0/600	6163142500	30,46	6165122500	64,06	6166122500	115,37	0/600
0/1000	6163142600	30,46	6165122600	66,32	6166122600	115,37	0/1000



DISPONIBLES TAMBIÉN CON ROSCA NPT

	MANOMETRO TODO INOX SIN GLICERINA, RELLENABLE TOMA POSTERIOR BSPP						
	CLASE 1,6		CLASE 1		CLASE 1		
	Ø63	1/4"	Ø100	1/2"	Ø150	1/2"	
ESCALA BAR	CODIGO	TARIFA	CODIGO	TARIFA	CODIGO	TARIFA	ESCALA BAR
-1/+0,6	6163240100	31,33	6165220100	75,69	6166220100	115,37	-1/+0,6
-1/+1,5	6163240200	31,33	6165220200	75,69	6166220200	115,37	-1/+1,5
-1/+3	6163240300	31,33	6165220300	75,69	6166220300	115,37	-1/+3
-1/+5	6163240400	31,33	6165220400	75,69	6166220400	115,37	-1/+5
-1/+9	6163240500	31,33	6165220500	75,69	6166220500	115,37	-1/+9
-1/+15	6163240600	31,33	6165220600	75,69	6166220600	115,37	-1/+15
-1/+24	6163240700	31,33	6165220700	75,69	6166220700	115,37	-1/+24
-1/0	6163240800	31,33	6165220800	75,69	6166220800	115,37	-1/0
0/0,6			6165220900	75,69	6166220900	115,37	0/0,6
0/1	6163241000	31,33	6165221000	75,69	6166221000	115,37	0/1
0/1,6	6163241100	31,33	6165221100	75,69	6166221100	115,37	0/1,6
0/2,5	6163241200	31,33	6165221200	75,69	6166221200	94,83	0/2,5
0/4	6163241300	31,33	6165221300	75,69	6166221300	94,83	0/4
0/6	6163241400	31,33	6165221400	75,69	6166221400	94,83	0/6
0/10	6163241500	31,33	6165221500	75,69	6166221500	94,83	0/10
0/16	6163241600	31,33	6165221600	75,69	6166221600	94,83	0/16
0/25	6163241700	31,33	6165221700	75,69	6166221700	94,83	0/25
0/40	6163241800	31,33	6165221800	75,69	6166221800	94,83	0/40
0/60	6163241900	31,33	6165221900	75,69	6166221900	115,37	0/60
0/100	6163242000	31,33	6165222000	75,69	6166222000	115,37	0/100
0/160	6163242100	31,33	6165222100	75,69	6166222100	115,37	0/160
0/250	6163242200	31,33	6165222200	75,69	6166222200	115,37	0/250
0/315	6163242300	31,33	6165222300	75,69	6166222300	115,37	0/315
0/400	6163242400	31,33	6165222400	75,69	6166222400	115,37	0/400
0/600	6163242500	31,33	6165222500	75,69	6166222500	115,37	0/600
0/1000	6163242600	31,33	6165222600	75,69	6166222600	115,37	0/1000



Ø 63	1/4" BSPP RADIAL		1/4" BSPP POST.		Ø 100	1/2" BSPP RADIAL		1/2" BSPP POST.	
	CLASE 1,6 SECO CARCASA INOX MECANICA LATON		CLASE 1,6 SECO CARCASA INOX MECANICA LATON			CLASE 1,6 SECO CARCASA INOX MECANICA LATON		CLASE 1,6 SECO CARCASA INOX MECANICA LATON	
									
mBar	CODIGO	TARIFA	CODIGO	TARIFA	mBar	CODIGO	TARIFA	CODIGO	TARIFA
-200/400	6133142502	39,72			-200/400				
-600/0	6133142501	39,72	6133242501	42,47	-600/0	6105122501	77,98	6105222501	91,66
-400/0	6133142401	39,72	6133242401	42,47	-400/0	6105122401	77,98	6105222401	91,66
-250/0	6133142201	39,72	6133242201	42,47	-250/0	6105122201	77,98	6105222201	91,66
-160/0	6133142101	39,72	6133242101	42,47	-160/0	6105122101	77,98	6105222101	91,66
-100/0	6133142001	39,72	6133242001	42,47	-100/0	6105122001	77,98	6105222001	91,66
-60/0	6133141901	39,72	6133241901	42,47	-60/0	6105121901	77,98	6105221901	91,66
-40/0	6133141801	39,72	6133241801	42,47	-40/0	6105121801	77,98	6105221801	91,66
-25/0	6133141701	39,72	6133241701	42,47	-25/0	6105121701	77,98	6105221701	91,66
0/25	6133141700	39,72	6133241700	42,47	0/25	6105121700	77,98	6105221700	91,66
0/40	6133141800	39,72	6133241800	42,47	0/40	6105121800	77,98	6105221800	91,66
0/60	6133141900	31,47	6133241900	42,47	0/60	6105121900	59,04	6105221900	84,43
0/100	6133142000	31,47	6133242000	42,47	0/100	6105122000	59,04	6105222000	84,43
0/160	6133142100	31,47	6133242100	42,47	0/160	6105122100	59,04	6105222100	84,43
0/250	6133142200	31,47	6133242200	42,47	0/250	6105122200	59,04	6105222200	84,43
0/400	6133142400	31,47	6133242400	42,47	0/400	6105122400	59,04	6105222400	84,43
0/600	6133142500	31,47	6133242500	42,47	0/600	6105122500	59,04	6105222500	84,43





Ø 63	1/4" BSPP RADIAL	
	CLASE 1,6 SECO TODO INOX	
		
mBar	CODIGO	TARIFA
0/100	6123142000	60,37
0/160	6123142100	60,37
0/250	6123142200	60,37

Ø 100	1/2" BSPP RADIAL		Ø 150	1/2" BSPP RADIAL	
	CLASE 1,6 SECO TODO INOX			CLASE 1,6 SECO TODO INOX	
					
mBar	CODIGO	TARIFA	mBar	CODIGO	TARIFA
-20/+20	6125121802	92,70			
-15/+25	6125121803	92,70			
-100/0	6125122001	92,70			
			0/10	6126121500	142,98
0/16	6125121600	63,04	0/16	6126121600	142,98
0/25	6125121700	63,04	0/25	6126121700	142,98
0/40	6125121800	63,04	0/40	6126121800	142,98
0/60	6125121900	63,04	0/60	6126121900	142,98
0/100	6125122000	63,04	0/100	6126122000	142,98
0/160	6125122100	63,04	0/160	6126122100	142,98
0/250	6125122200	63,04	0/250	6126122200	142,98
0/400	6125122400	63,04	0/400	6126122400	142,98
0/600	6125122500	63,04	0/600	6126122500	142,98

Ø	1/2" BSPP RADIAL	
	CLASE 1 SECO CARCASA INOX MECANICA LATON	
		
mBar	CODIGO	TARIFA
0/40	6115121800	88,22
0/60	6115121900	88,22
0/100	6115122000	88,22
0/160	6115122100	88,22
0/250	6115122200	88,22
0/400	6115122400	88,22
0/600	6115122500	88,22

Ø 63	1/2" BSPP RADIAL	
	CLASE 1,6 SECO DESENGRASADO EN-562 REGULADORES	
		
Bar	CODIGO	TARIFA
0/2,5	6093141200	10,26
0/10	6093141500	10,26
0/16	6093141600	10,26
0/25	6093141700	10,26
0/40	6093141800	10,26
0/60	6093141900	10,26
0/100	6093142000	10,26
0/315	6093142300	10,26
0/400	6093142400	10,26

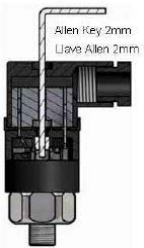

<p>MANOMETROS PATRON CLASE 0,5 Y 0,25 Ø100 / Ø150</p> 	<p>MAN. DIGITALES CLASE 0,5 / 0,2 / 0,05</p> 	<p>MANOMETROS CON CONTACTOS</p> 	<p>SEPARADORES ALIMENTARIO INOX</p> 
<p>SEPARADORES</p> 	<p>TRANSMISORES DE PRESION</p> 	<p>TERMOMETROS CALEF / REFRIGERACION</p> 	
<p>TERMOMETROS CAPILLA</p> 	<p>PT100 KN / DIN B / ATEX</p> 	<p>TERMOMETRO INDUSTRIAL</p> 	<p>TERMOMETRO DIGITAL</p> 
<p>BOMBAS CALIBRACION</p> 	<p>BOMBAS COMPROBACION</p> 	<p>BALANZA PESOS MUERTOS</p> 	<p>CALIBRADOR TEMPERATURA</p> 
<p>PRESOSTATOS</p> 	<p>PRESOSTATOS NAUTILUS</p> 	<p>PRESOSTATO COMPRESOR</p> 	<p>GRIFOS Y ADAPTADORES</p> 

NO DUDE EN CONSULTANOS

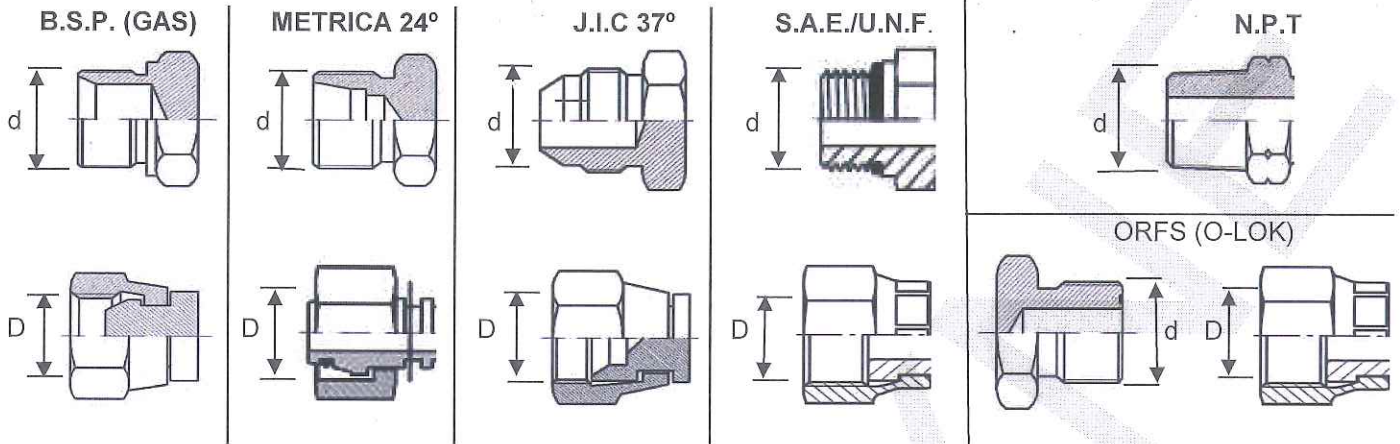

mm.	MACHO d	HEMBRA D
6,9		METRICA 8x1
8	METRICA 8x1	
8,4		JIC/SAE 3/8"-24
8,5		BSP 1/8"
8,9		METRICA 10x1
9,4	JIC/SAE 3/8"-24	
9,7	BSP 1/8"	
9,8		JIC/SAE 7/16"-20
10	METRICA 10x1	
10,2	NPT 1/8" -27	
10,3		METRICA 12x1,5
11	JIC/SAE 7/16-20	
11,4		BSP 1/4"
11,4		JIC/SAE 1/2"-20
12	METRICA 12x1,5	
12,3		METRICA 14x1,5
12,6	JIC/SAE 1/2"-20	
12,8		JIC/SAE 9/16"-18
13,1	BSP 1/4"	
13,7	NPT 1/4"-18	
14	METRICA 14x1,5	
14,2	JIC/SAE 9/16"-18	
14,3		METRICA 16X1,5
14,9		BSP 3/8"
15,8		JIC/SAE 11/16"-16
16	METRICA 16x1,5	
16,3		METRICA 18x1,5
16,6	BSP 3/8"	
17,2	NPT 3/8"-18	
17,4	JIC/SAE 11/16"-16	JIC/SAE 3/4"-16
18	METRICA 18x1,5	
18,3		METRICA 20x1,5
18,6		BSP 1/2"
19	JIC/SAE 3/4"16	JIC/SAE 13/16"-16
20	METRICA 20x1,5	
20,3		METRICA 22x1,5

mm.	MACHO d	HEMBRA D
20,4		JIC/SAE 7/8-16
20,5	JIC/SAE 13/16"-16	BSP 5/8"
20,9	BSP 1/2"	
21,3	NPT 1/2"-14	
22	METRICA 22x1,5	
22,1	JIC/SAE 7/8"-14	
22,3		METRICA 24x1,5
22,9	BSP 5/8"	
23,5		JIC/SAE 1"-14
24	METRICA 24x1,5	
24,1		BSP 3/4"
24,3		METRICA 26x1,5
24,8		JIC/SAE 1"1/16-12
25,3	JIC/SAE 1"-14	METRICA 27x1,5
26	METRICA 26x1,5	
26,4	BSP 3/4"	
26,6	NPT 3/4"-14	
26,9	JIC/SAE 1"1/16-12	
27	METRICA 27x1,5	
27,8		METRICA 30x2
28,1		JIC/SAE 1"3/16-12
28,3		METRICA 30x1,5
30	METRICA 30x1,5	
30	METRICA 30x2	
30,1	JIC/SAE 1"3/16-12	
30,2		BSP 1"
30,3		METRICA 32x1,5
31,2		JIC/SAE 1"5/16-12
31,3		METRICA 33x1,5
32	METRICA 32x1,5	
33	METRICA 33x1,5	
33,2	JIC/SAE 1"5/16-12	
33,2	BSP 1"	
33,4	NPT 1"-11,5	
33,8		METRICA 36s2
34,3		METRICA 36x1,5

mm.	MACHO d	HEMBRA D
34,4		JIC/SAE 1"7/16-12
36	METRICA 36x1,5	
36	METRICA 36x2	
36,3	JIC/SAE 1"7/16-12	METRICA 38x1,5
38	METRICA 38x1,5	
38,9		BSP 1"1/4
39,2		JIC/SAE 1"5/8-12
39,8		METRICA 42x2
40,7		JIC/SAE 1"11/16-12
41,2	JIC/SAE 1"5/8-12	
41,9	BSP 1"1/4	
42	METRICA 42x2	
42,1	NPT 1"1/4-11.5	
42,8	JIC/SAE 1"11/16-12	METRICA 45x2
43,3		METRICA 45x1,5
44,8		BSP 1"1/2
45	METRICA 45x1,5	
45	METRICA 45x2	
45,5		JIC/SAE 1"7/8-12
47,5	JIC/SAE 1"7/8-12	
47,8	BSP 1"1/2	
48,2	NPT 1"1/2-11.5	
48,7		JIC/SAE 2"-12
49,8		METRICA 52x2
50,3		METRICA 52x1,5
50,7	JIC/SAE 2"-12	
52	METRICA 52x1,5	
52	METRICA 52x2	
56,6		BSP 2"
59,6	BSP 2"	
60,3	NPT 2"-11.5	
61,4		JIC/SAE 2"1/2-12
62,8		METRICA 65x2
63,4	JIC/SAE 2"1/2-12	
65	METRICA 65x2	